

EUCHNER

Operating Instructions

Safety Systems
MGB-B-...-PN (PROFINET)
With Data Structure Type C (Expanded)
From V 3.30.1

EN

Contents

1.	About this document	4
1.1.	Scope.....	4
1.1.1.	Notes on older product versions	4
1.2.	Target group	4
1.3.	Key to symbols.....	4
1.4.	Supplementary documents	4
2.	Correct use	5
3.	Exclusion of liability and warranty	5
4.	General safety precautions	6
5.	System overview	7
5.1.	Bus module MGB-B-...-PN (PROFINET).....	7
5.2.	System components and spare parts	7
6.	Mounting	8
6.1.	Dimension drawing for bus module MGB-B-...-PN (PROFINET)	8
7.	Controls and indicators	9
8.	Electrical connection	10
8.1.	Connections on the bus module	10
8.1.1.	Ethernet connection on the bus module	10
9.	Setup	11
9.1.	Integrating into PROFINET and PROFIsafe	11
9.2.	Replacement of an MGB system without programming device	11
9.3.	Resetting system to factory settings	11
9.4.	PROFINET data bytes for “standard” and “expanded” data structures (data blocks for non-safe functions).....	12
9.5.	PROFINET and PROFIsafe data bytes for data structure type A (standard).....	12
9.5.1.	PROFINET data bytes (data blocks for non-safe functions)	12
9.5.2.	PROFIsafe data bytes (data block for safe functions).....	13
9.6.	PROFINET and PROFIsafe data bytes for data structure type C (expanded)	14
9.6.1.	Data block for “expanded” MGB bus module	14
9.6.2.	Data block for operating mode selector function	14
9.6.3.	Additional button functions.....	15
9.6.4.	Data block for “expanded” diagnostics function	15
9.6.5.	“Expanded” PROFIsafe data bytes	16
9.6.6.	Data block for “expanded” PROFIsafe	16
10.	MGB system diagnostic messages	18
11.	Technical data	20
12.	Troubleshooting	21

13.	Service	21
14.	Inspection and service	21
15.	Replacement of the system.....	21
16.	Declaration of conformity	22

1. About this document

1.1. Scope

These operating instructions apply to all MGB-B-...-PN (PROFINET) with the “expanded” data structure from version number V 3.30.1. These operating instructions, the document *Safety information* and any enclosed data sheet form the complete user information for your device.





1.1.1. Notes on older product versions

Products with lower product versions or without a version number are not described by these operating instructions. Please contact our support team in this case.

1.2. Target group



Design engineers and installation planners for safety devices on machines, as well as setup and servicing staff possessing special expertise in handling safety components.

1.3. Key to symbols

Symbol/depiction	Meaning
	Printed document
	Document is available for download at www.euchner.com
 DANGER WARNING CAUTION	Safety precautions Danger of death or severe injuries Warning about possible injuries Caution Slight injuries possible
 NOTICE Important!	Notice about possible device damage Important information
Tip	Useful information

1.4. Supplementary documents

The overall documentation for this device consists of the following documents:

Document title (document number)	Contents	
Safety information (2525460)	Basic safety information	
Operating instructions (2124005)	(this document)	
Possibly enclosed data sheet	Item-specific information about deviations or additions	

	Important! Always read all documents to gain a complete overview of safe installation, setup and use of the device. The documents can be downloaded from www.euchner.com . For this purpose enter the doc. no. in the search box.
---	--

2. Correct use

The MGB bus module is used as a communication interface between the MGB system and PROFINET.

The device is operated as an IO device in the PROFINET (PROFIsafe).

The bus module can contain various controls and indicators for safe functions and functions that are not related to safety. Refer to the enclosed data sheet for configuration details.

In conjunction with integrated or connected safety components, the device can be used for tasks related to machine safety.

The customer is responsible for the safe overall function, especially for the safe integration into the PROFIsafe environment.

Before safety components are used, a risk assessment must be performed on the machine, e.g. in accordance with

- EN ISO 13849-1
- EN ISO 12100
- IEC 62061

Correct use includes compliance with the relevant requirements for installation and operation, in particular

- EN ISO 13849-1
- EN 60204-1

The MGB bus module can be combined only with the intended modules in the MGB system family. As a rule, all system components are pre-assembled from the factory and subsequent changes are not possible.

On the modification of system components, Euchner provides no warranty for safe function.



Important!

- The user is responsible for the proper integration of the device into a safe overall system. For this purpose, the overall system must be validated, e.g. in accordance with EN ISO 13849-2.
- Correct use requires observing the permissible operating parameters (see chapter 11. *Technical data on page 20*).
- If a data sheet is included with the product, the information on the data sheet applies.

3. Exclusion of liability and warranty

In case of failure to comply with the conditions for correct use stated above, or if the safety regulations are not followed, or if any servicing is not performed as required, liability will be excluded and the warranty void.

4. General safety precautions

Safety components or components that are integrated into the safety circuit perform a personnel protection function. Incorrect installation or tampering can lead to severe injuries to personnel.

A possible safety function of the system while the machine is in operation may no longer be ensured if the device is connected incorrectly or used incorrectly.



WARNING

- › Safety components must not be bypassed, turned away, removed or otherwise rendered ineffective. On this topic pay attention in particular to the measures for reducing the possibility of bypassing according to EN ISO 14119:2013, section 7.
- › Mounting, electrical connection and setup only by authorized personnel possessing the following knowledge:
 - specialist knowledge in handling safety components
 - knowledge about the applicable EMC regulations
 - knowledge about the applicable regulations on operational safety and accident prevention.



Important!

Prior to use, read the operating instructions and keep these in a safe place. Ensure the operating instructions are always available during mounting, setup and servicing. For this reason you should archive a printed copy of the operating instructions. You can download the operating instructions from www.euchner.com.

5. System overview

5.1. Bus module MGB-B-...-PN (PROFINET)

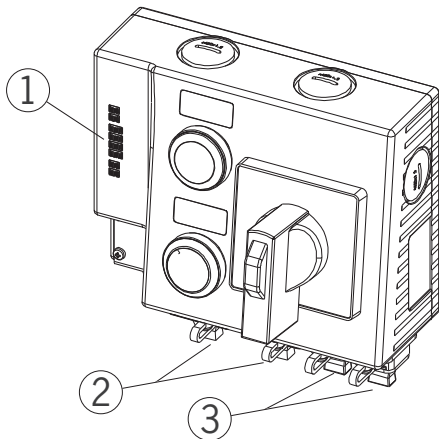

- Key:**
- ① LED indicator
 - ② Sockets for power supply
 - ③ Sockets for PROFINET connection

Figure 1: Bus module MGB-B-...-PN (PROFINET)

5.2. System components and spare parts

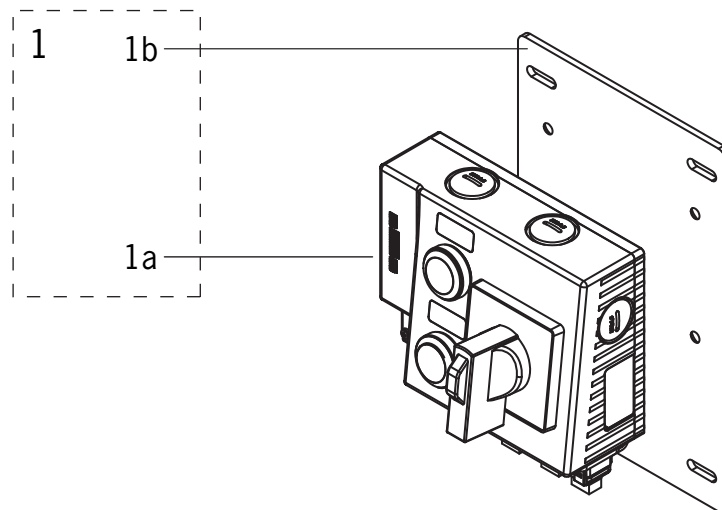

Figure 2: System components and spare parts

Item	Designation	Use/description	Order no./item
1	Bus module MGB-B-... comprising:	Mounting plate included	123759 MGB-B-A1W2A2-PN-123759
	1a - Bus module		-
	1b - Mounting plate	For bus module MGB-B-...	110071 MGB-A-MOUNTING PLATE-B-110071

6. Mounting

Refer to the enclosed data sheet for detailed instructions on mounting.

6.1. Dimension drawing for bus module MGB-B-...-PN (PROFINET)

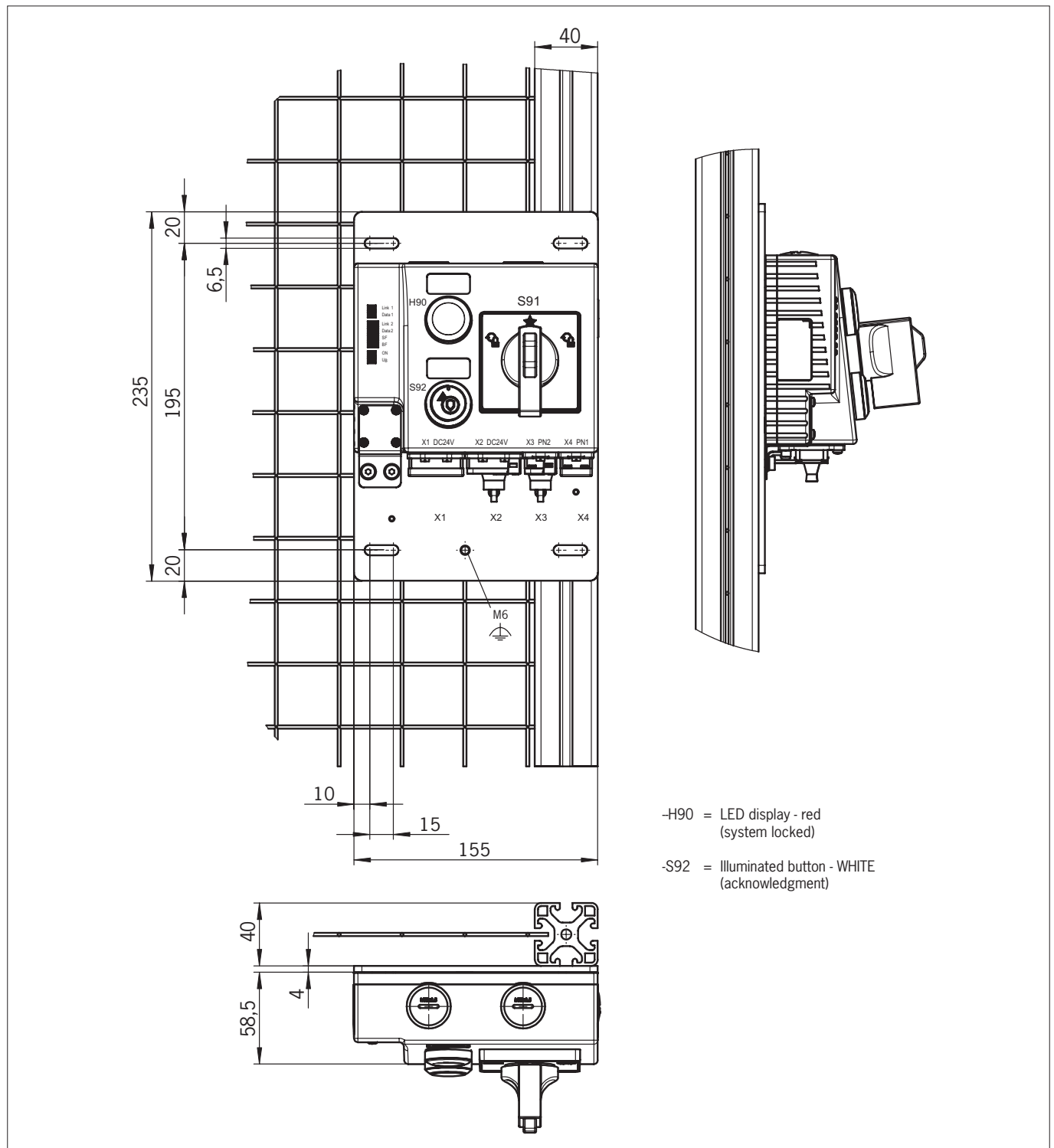
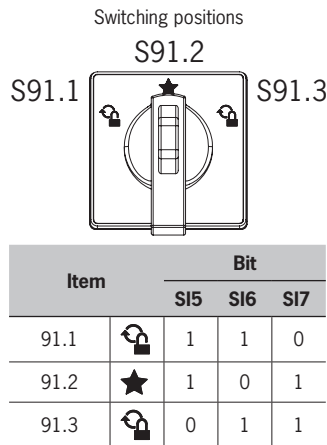

Figure 3: Dimension drawing for bus module MGB-B-...-PN (PROFINET)

7. Controls and indicators

LEDs on the bus module

LED	Color	Description
Link 1 and Link 2	green	Bus connector inserted: statically on
Data 1 and Data 2	yellow	Data transfer: flashing
SF	red	System error: statically on (see chapter on diagnostic messages of the MGB system)
BF	red	Bus error: statically on (see chapter on diagnostic messages of the MGB system)
ON	green	Self-test OK: statically on Device passivated: flashing
UB	green	Power supply OK: statically on



Binary coding of the DIP switches for PROFI-safe address
(factory setting: 135)

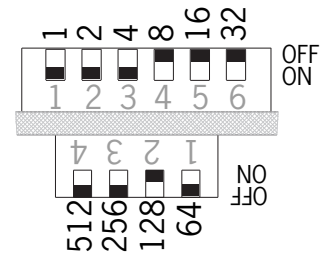

default address:
 $128 + 4 + 2 + 1 = 135$

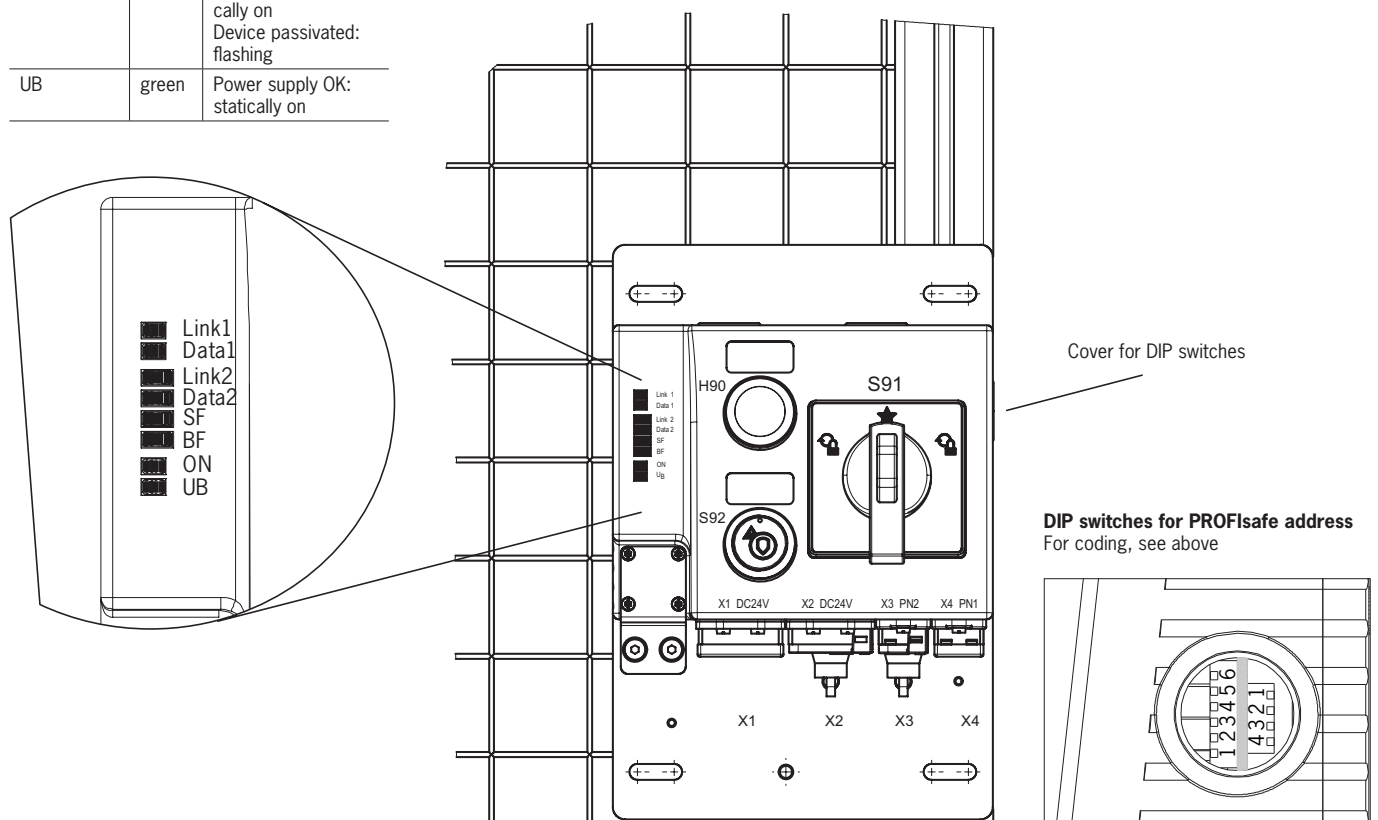





Figure 4: Indicators and controls/binary coding of the DIP switches for PROFI-safe address (factory setting: 135)

8. Electrical connection

	<p>WARNING</p> <p>In the event of a fault, loss of the safety function due to incorrect connection.</p> <ul style="list-style-type: none"> › Mounting must be performed only by authorized personnel.
	<p>CAUTION</p> <p>Risk of damage to equipment or malfunctions as a result of incorrect connection.</p> <ul style="list-style-type: none"> › All the electrical connections must either be isolated from the mains supply by a safety transformer according to EN IEC 61558-2-6 with limited output voltage in the event of a fault, or by other equivalent insulation measures. › In order to avoid EMC interference, follow the EMC notes on devices in the immediate vicinity of the MGB system and its cables. › In order to avoid EMC interference, the physical environmental and operating conditions at the installation site of the device must comply with the requirements according to the standard DIN EN 60204-1:2006, section 4.4.2/EMC).
	<p>Important!</p> <ul style="list-style-type: none"> › The supply for further devices on the bus may be forwarded via the Euchner MGB system. The entire supply current through the MGB must not be higher than specified in chapter 11. <i>Technical data on page 20.</i> › The functional earth \oplus must be connected. An M6 thread hole is available on the mounting plate for this purpose. › If the device does not appear to function when operating voltage is applied (e.g. UB LED does not illuminate), the device must be returned unopened to the manufacturer.

8.1. Connections on the bus module

The bus module includes the PROFINET connections (X3 and X4) and the power supply connections (X1 and X2). Connection is performed via push-pull plugs according to IEC 61076-3-117, variant 14.

The bus module includes a PROFINET RT switch for Ethernet connection.

8.1.1. Ethernet connection on the bus module

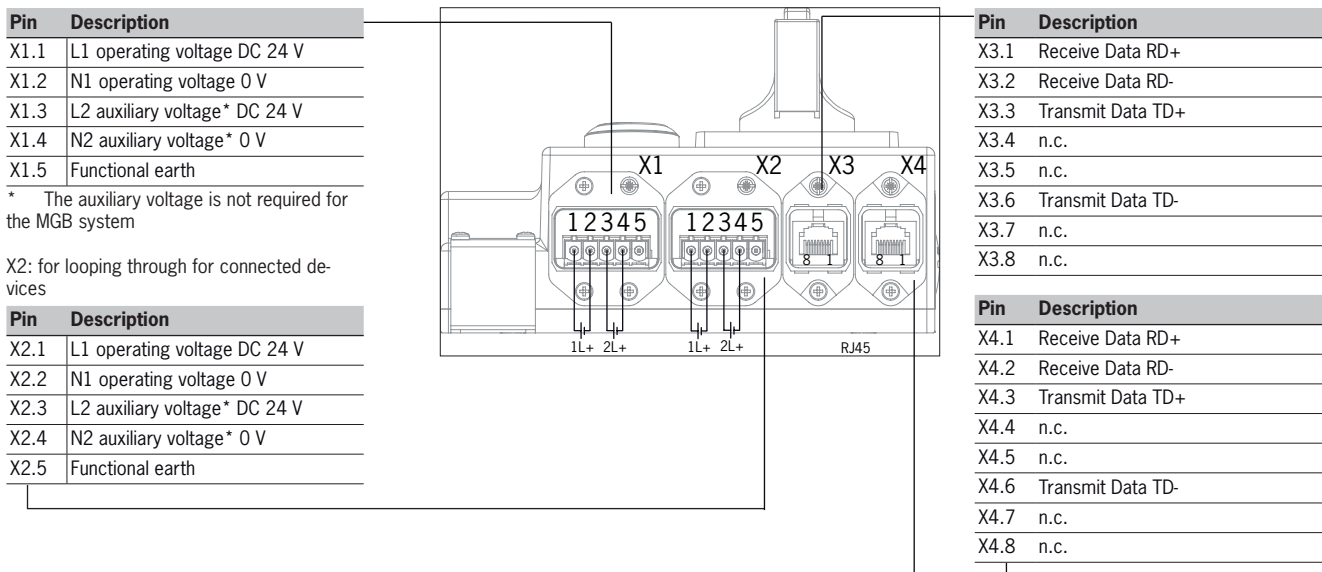



Figure 5: Terminal assignment of bus module MGB-B-...-PN (PROFINET)

9. Setup

9.1. Integrating into PROFINET and PROFIsafe

	<p>WARNING</p> <p>The parameters "Update time" and "F-WD-Time" have a decisive effect on the reaction time of the system. A possible safety function could be lost if the reaction times are too long.</p>
	<p>Important!</p> <p>You will require the corresponding GSD file in GSDML format in order to integrate the MGB system:</p> <ul style="list-style-type: none"> ▸ GSDML-Vx.x-Euchner-MGB_PN_D-YYYYMMDD.xml <p>You will find the GSD file in the Download area at www.euchner.com.</p> <p>Prior to setup, the GSD file must be imported into the configuration software of the control system (see control system manual).</p>

You must perform the following steps to integrate the MGB system into PROFINET:

1. Configure the MGB system with the configuration software of the control system and assign parameters.

The following PROFINET parameters must be set:

- Device name (factory setting in GSD file): [euchnermgb].
- IP address: optionally fixed or dynamic
- Update time:
 - Recommendation [32 ms]
 - Maximum value [128 ms]
 - (with number of repeat cycles = 3)

The following PROFIsafe parameters must be set:

- F_dest_adr (PROFIsafe address): this is generally assigned automatically by the control system.
- F_WD_Time (time during which the control system expects a response from the PROFIsafe device): [factory setting 600 ms]

2. Set the PROFIsafe address (F_Source_Addr) on the MGB system using the DIP switches (see Figures 3 and 4).

3. Save the configuration and transfer it to the MGB system.

9.2. Replacement of an MGB system without programming device

If servicing is required, the MGB system is easy to replace with a new one. For this purpose, the following prerequisites must be met:

- The DIP switch settings on the new device must match those on the old device.
- Your Profinet master must support the automatic replacement of Profinet devices.
- Your Profinet topology must be correctly configured.
- There must be no device name in the MGB system.
 - This field is empty in the delivery state. Systems that already contain a name must first be reset to the factory settings.

Once these conditions are met, simply replace the old system with the new system.

The Profinet bus does not need to be switched off for this purpose.

9.3. Resetting system to factory settings

You will find detailed instructions in the manual for the configuration software for your control system.

9.4. PROFINET data bytes for “standard” and “expanded” data structures (data blocks for non-safe functions)



Important!

This device can be operated in the “standard” or “expanded” configuration. Additional functions are available in the “expanded” configuration (see chapter 9.6.3. *Additional button functions on page 15*).

Select one of the configurations by bringing together the corresponding modules via drag & drop in the configuration software of your control system.

The modules are easy to distinguish by means of the commentary block. Plug-in standard and expanded modules must not be mixed. The modules must be selected prior to the first Power On process. Another Power On is required if modules are to be exchanged.

These data blocks are automatically assigned to the designated slots in the configuration software of the control system when your MGB system is placed. This assignment changes according to MGB system. The exact assignment of the slots and the exact bit allocation for your device can be seen in the data sheet. The data sheet is included with every MGB system.

9.5. PROFINET and PROFIsafe data bytes for data structure type A (standard)

9.5.1. PROFINET data bytes (data blocks for non-safe functions)



NOTICE

- › See the supplied data sheet for details on the bit assignment.
- › For details, see chapter 10. *MGB system diagnostic messages on page 18*.

Profinet RT modules 3 bytes IO:

Assignment in input area of the bus master:

1st byte	I 8	I 7	I 6	I 5	I 4	I 3	I 2	I 1
2nd byte	I 16	I 15	I 14	I 13	I 12	I 11	I 10	I 9
Depends on your configuration variant (refer to the data sheet of your device for the exact bit allocation)								

Assignment in output area of the bus master:

1st byte	O 8	O 7	O 6	O 5	O 4	O 3	O 2	O 1
2nd byte	O 16	O 15	O 14	O 13	O 12	O 11	O 10	O 9
Depends on your configuration variant (refer to the data sheet of your device for the exact bit allocation)								

3rd byte	I 24	I 23	I 22	I 21	I 20	I 19	I 18	I 17
----------	------	------	------	------	------	------	------	------

3rd byte	O 24	O 23	O 22	O 21	O 20	O 19	O 18	O 17
----------	------	------	------	------	------	------	------	------

- I 17: Device diagnostics (PROFIsafe error 72): message present. Diagnostic code: see table of device-specific messages.
- I 18: n.c.
- I 19: n.c.
- I 20: n.c.
- I 21: Device diagnostics, device-specific message 272(6) or 273(6) “Error in operating mode selector”
- I 22: n.c.
- I 23: n.c.
- I 24: n.c.

- O 17: Device diagnostics: acknowledge message; acknowledgment of I 19, I 20 or I 21. I 17 is also acknowledged if only one message is present
- O 18: n.c.
- O 19: n.c.
- O 20: n.c.
- O 21: n.c.
- O 22: n.c.
- O 23: n.c.
- O 24: n.c.

9.5.2. PROFIsafe data bytes (data block for safe functions)

Safe PROFIsafe data are transmitted in addition to the non-safe PROFINET data. These data include all information about the door position and guard locking, emergency stop and enabling switch, for example.



NOTICE

› See the supplied data sheet for details on the bit assignment.



Important!

Never use the status bits for safety functions!

Profisafe assignment in input area of the bus master:

Byte n+0	SI 8	SI 7	SI 6	SI 5	SI 4	SI 3	SI 2	SI 1
Byte n+1	SI 16	SI 15	SI 14	SI 13	SI 12	SI 11	SI 10	SI 9
Byte n+2	Profisafe internal							
Byte n+3	Profisafe internal							
Byte n+4	Profisafe internal							
Byte n+5	Profisafe internal							

Profisafe assignment in the output area of the bus master:

Byte n+0	SO 8	SO 7	SO 6	SO 5	SO 4	SO 3	SO 2	SO 1
Byte n+1	SO 16	SO 15	SO 14	SO 13	SO 12	SO 11	SO 10	SO 9
Byte n+2	Profisafe internal							
Byte n+3	Profisafe internal							
Byte n+4	Profisafe internal							
Byte n+5	Profisafe internal							

SI 1:	Emergency stop
SI 2:	Enabling switch Enabling contacts closed (three-stage enabling switch in center position), no evaluation of the edges
SI 3:	n.c.
SI 4:	n.c.
SI 5:	n.c.
SI 6:	
SI 7:	Operating mode selector (3 bits occupied)
SI 8:	
SI 9:	n.c.
SI 10:	n.c.
SI 11:	n.c.
SI 12:	n.c.
SI 13:	n.c.
SI 14:	n.c.
SI 15:	n.c.
SI 16:	Reserved for customer-specific function

SO 1:	n.c.
SO 2:	n.c.
SO 3:	n.c.
SO 4:	n.c.
SO 5:	n.c.
SO 6:	n.c.
SO 7:	n.c.
SO 8:	n.c.
SO 9:	n.c.
SO 10:	n.c.
SO 11:	n.c.
SO 12:	n.c.
SO 13:	n.c.
SO 14:	n.c.
SO 15:	n.c.
SO 16:	n.c.

9.6. PROFINET and PROFIsafe data bytes for data structure type C (expanded)

9.6.1. Data block for “expanded” MGB bus module

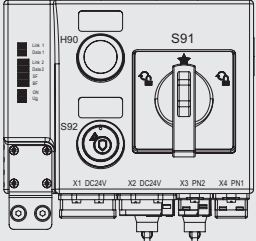
MGB module	Slot	Required memory in data area of the control system (IO controller) (Refer to the data sheet of your device for the exact bit allocation)									
Bus module (Configuration example) 	See data sheet for slot assignment	Input area (2 bytes)	Control element	-	-	-	-	-	S92	-	-
			Bit	I0.7	I0.6	I0.5	I0.4	I0.3	I0.2	I0.1	I0.0
		Output area (1 byte)	Bit	I1.7	I1.6	I1.5	I1.4	I1.3	I1.2	I1.1	I1.0
			Display	-	-	-	-	-	H92	-	H90
		Bit	O0.7	O0.6	O0.5	O0.4	O0.3	O0.2	O0.1	O0.0	

Bit allocation for 1st byte

Input area	Bit	Description	Output area	Bit	Description
	I0.0	Depends on your configuration variant (refer to the data sheet of your device for the exact bit allocation)		Depends on your configuration variant (refer to the data sheet of your device for the exact bit allocation)	O0.0
I0.1					
I0.2					
I0.3					
I0.4					
I0.5					
I0.6					
I0.7					

Bit allocation for 2nd byte

Input area	Bit	Description
	I1.0	Depends on your configuration variant (refer to the data sheet of your device for the exact bit allocation)
	I1.1	
	I1.2	
	I1.3	
	I1.4	
	I1.5	
	I1.6	
I1.7		

9.6.2. Data block for operating mode selector function

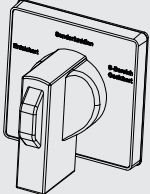

Function	Slot	Required memory in data area of the control system (IO controller) (Refer to the data sheet of your device for the exact bit allocation)									
Operating mode selector 	See data sheet for slot assignment	Input area (1 byte)	Switch (coding 2 of 3)	-	-	-	-	-	S91	-	-
			Bit	I0.7	I0.6	I0.5	I0.4	I0.3	I0.2	I0.1	I0.0
		Output area (1 byte)	Display	-	-	-	-	-	-	-	-
			Bit	O0.7	O0.6	O0.5	O0.4	O0.3	O0.2	O0.1	O0.0

Bit allocation for 1st byte

Input area	Bit	Description	Output area	Bit	Description
	I0.0	Operating mode selector, 1st status bit		O0.0	n.c.
	I0.1	Operating mode selector, 2nd status bit		O0.1	n.c.
	I0.2	Operating mode selector, 3rd status bit		O0.2	n.c.
	I0.3	n.c.		O0.3	n.c.
	I0.4	n.c.		O0.4	n.c.
	I0.5	n.c.		O0.5	n.c.
	I0.6	n.c.		O0.6	n.c.
I0.7	n.c.	O0.7	n.c.		

9.6.3. Additional button functions

Integrated light control in bus module

Selector switch position (S91)		Red light (H90)	White light (H92)
	Locked	on (if bit H90 = 1) off (if H90 = 0)	off
	Special function		
	▸ On changeover to special function	off	flashing
	▸ After acknowledgment (press S92) AND feedback from PLC (H90=1)	flashing	on
	Unlocked		
	▸ On changeover to unlocked	off	flashing
	▸ After acknowledgment (press S92)	off	on

9.6.4. Data block for “expanded” diagnostics function

Function	Slot	Required memory in data area of the control system (IO controller) (see below for exact bit allocation)									
		Message	-	-	272(6) 273(6)	-	-	-	-	72	
Diagnostics	See data sheet for slot assignment	Input area (2 bytes)	Bit	I0.7	I0.6	I0.5	I0.4	I0.3	I0.2	I0.1	I0.0
				I1.7	I1.6	I1.5	I1.4	I1.3	I1.2	I1.1	I1.0
			Output area (2 bytes)	Acknowledgment	-	-	-	-	-	-	-
		Bit		O0.7	O0.6	O0.5	O0.4	O0.3	O0.2	O0.1	O0.0
				O1.7	O1.6	O1.5	O1.4	O1.3	O1.2	O1.1	O1.0

Bit allocation			
Input area		Output area	
Bit	Description	Bit	Description
I0.0	Device diagnostics (PROFIsafe error 72): message present. Diagnostic code: see table of device-specific messages.	O0.0	Device diagnostics: acknowledge message, acknowledgment of I0.2, I0.3 or I0.4. I0.0 is also acknowledged if only one message is present
I0.1	n.c.	O0.1	n.c.
I0.2	n.c.	O0.2	n.c.
I0.3	n.c.	O0.3	n.c.
I0.4	n.c.	O0.4	n.c.
I0.5	Device diagnostics, device-specific message 272 (6) or 273 (6) “operating mode selector”	O0.5	n.c.
I0.6	n.c.	O0.6	n.c.
I0.7	n.c.	O0.7	n.c.
I1.0	n.c.	O1.0	n.c.
I1.1	n.c.	O1.1	n.c.
I1.2	n.c.	O1.2	n.c.
I1.3	n.c.	O1.3	n.c.
I1.4	n.c.	O1.4	n.c.
I1.5	n.c.	O1.5	n.c.
I1.6	n.c.	O1.6	n.c.
I1.7	n.c.	O1.7	n.c.

9.6.5. “Expanded” PROFIsafe data bytes

The “standard” PROFIsafe data block includes all safe functions. It is subdivided as follows:

- › 2 input bytes of data for the functions (e.g. emergency stop switch position)
- › 2 additional input bytes (empty)
- › 4 input bytes used within PROFIsafe
- › 1 output byte for the functions
- › 1 additional output byte (empty)
- › 4 output bytes used within PROFIsafe

All data bits are present in parallel in the non-safe PROFINET data area and can be used as a status bit there.



Important!

Never use the status bits for safety functions!

9.6.6. Data block for “expanded” PROFIsafe



Important!

› Refer to the data sheet enclosed with your MGB system for the exact bit allocation. Use only bits that are specified according to the data sheet.

Function	Slot	Required memory in data area of the control system (IO controller) (see below for exact bit allocation)										
Diagnostics	See data sheet for slot assignment	Function		S91 (operating mode selector)				-	-	-	-	-
		1st byte	SI0.7	SI0.6	SI0.5	SI0.4	SI0.3	SI0.2	SI0.1	SI0.0		
		Function		-	-	-	-	-	-	-	-	
		2nd byte	SI1.7	SI1.6	SI1.5	SI1.4	SI1.3	SI1.2	SI1.1	SI1.0		
		Function		-	BAW2Q	BAW1Q	-	-	-	-	-	
		3rd byte	SI2.7	SI2.6	SI2.5	SI2.4	SI2.3	SI2.2	SI2.1	SI2.0		
		Function		-	-	-	-	-	-	-	-	
		4th byte	SI3.7	SI3.6	SI3.5	SI3.4	SI3.3	SI3.2	SI3.1	SI3.0		
		Function										
		5th - 8th bytes		Used within PROFIsafe (control byte, CRC, etc.)								
		Function		-	-	-	ER	-	-	-	-	
		1st byte	SO0.7	SO0.6	SO0.5	SO0.4	SO0.3	SO0.2	SO0.1	SO0.0		
		Function		-	-	-	-	-	-	-	-	
		2nd byte	SO1.7	SO1.6	SO1.5	SO1.4	SO1.3	SO1.2	SO1.1	SO1.0		
		Function										
		3rd - 6th bytes		Used within PROFIsafe (control byte, CRC, etc.)								

Bit allocation for 1st byte					
Input area	Bit	Description	Output area	Bit	Description
	SI0.0	n.c.		S00.0	n.c.
	SI0.01	n.c.		S00.1	n.c.
	SI0.2	n.c.		S00.2	n.c.
	SI0.3	n.c.		S00.3	n.c.
	SI0.4	n.c.		S00.4	ER External reset
	SI0.5	Operating mode selector, 1st bit		S00.5	n.c.
	SI0.6	Operating mode selector, 2nd bit		S00.6	n.c.
	SI0.7	Operating mode selector, 3rd bit		S00.7	n.c.
Bit allocation for 2nd byte					
Input area	Bit	Description	Output area	Bit	Description
	SI1.0	n.c.		S01.0	n.c.
	SI1.1	n.c.		S01.1	n.c.
	SI1.2	n.c.		S01.2	n.c.
	SI1.3	n.c.		S01.3	n.c.
	SI1.4	n.c.		S01.4	n.c.
	SI1.5	n.c.		S01.5	n.c.
	SI1.6	n.c.		S01.6	n.c.
	SI1.7	Reserved for customer-specific function		S01.7	n.c.
Bit allocation for 3rd byte					
Input area	Bit	Description			
	SI2.0	n.c.			
	SI2.1	n.c.			
	SI2.2	n.c.			
	SI2.3	n.c.			
	SI2.4	n.c.			
	SI2.5	BAW1Q			
	SI2.6	BAW2Q			
	SI2.7	n.c.			
Bit allocation for 4th byte					
Input area	Bit	Description			
	SI3.0	n.c.			
	SI3.1	n.c.			
	SI3.2	n.c.			
	SI3.3	n.c.			
	SI3.4	n.c.			
	SI3.5	n.c.			
	SI3.6	n.c.			
	SI3.7	n.c.			

10. MGB system diagnostic messages

Profisafe messages

Display via *BF* LED (see *Figure 4*)

No.	Description	Measures/rectifying errors
64	Error when comparing the Profisafe destination address (F_Dest_Add)	1. Check DIP switch position 2. Restart system
65	Invalid Profisafe destination address (F_Dest_Add)	1. Check addressing 2. Restart system
66	Invalid Profisafe source address (F_Source_Add)	1. Check addressing 2. Restart system
67	Value for Profisafe time monitoring is 0 ms (F_WD_TIME)	1. Check system times 2. Restart system
68	Parameter F_SIL exceeds SIL of the device-specific application	1. Check settings 2. Restart system
69	Parameter F_CRC_Length does not match the generated values	1. Check settings 2. Restart system
70	Version for F_Parameter not correct	1. Check configuration 2. Restart system
71	Error CRC 1- (during booting)	1. Restart system
72	Device-specific diagnostics information (see manual)	With data structure type A: 1. Identify error via input bit I17 2. For troubleshooting, see the following table with device-specific messages With data structure type C: 1. Identify error via input bit IO.0 in the diagnostics data block 2. For troubleshooting, see the following table with device-specific messages

Device-specific diagnostic information

Display via *SF* LED (see *Figure 4*)

Discrepancy error (two-channel monitoring detected an error)

Notice:

- The discrepancy time is the maximum time during which channel 1 and channel 2 may have different signal states.
- If acknowledgment was unsuccessful, switch device off and on.

No.	Description	Measures/rectifying errors
272	Discrepancy time exceeded	Contact our support organization.
272(6)	Operating mode selector discrepancy time exceeded	Contact our support organization.

Test-pulse error (short-circuit monitoring detected an error)

Notice:

- If acknowledgment was unsuccessful, switch device off and on.

No.	Description	Measures/rectifying errors
273	Test pulses erroneous	Safety function is switched off while no test pulses are being detected. No acknowledgment necessary.
273(6)	Operating mode selector test pulses erroneous	With data structure type A: Safety function is switched off while no test pulses are being detected. Acknowledgment via output bit O17 necessary. With data structure type C: Safety function is switched off while no test pulses are being detected. Acknowledgment via output bit O0.0 in the diagnostics data block required.

Operating mode selector error

No.	Description	Measures/rectifying errors
275(1)	The plausibility check on the operating mode selector was erroneous	Contact our support organization.

PROFIsafe error

No.	Description	Measures/rectifying errors
276(1)	PROFIsafe starting error	Contact our support organization.
276(2)	RAM memory error	Contact our support organization.
276(3)	FLASH memory error	Contact our support organization.
276(4)	Communication error	Contact our support organization.
276(5)	Synchronization error	Contact our support organization.
276(6)	Voltage monitoring	Contact our support organization.

General messages of the overall system

No.	Description	Measures/rectifying errors
277(1)	MGB starting error	Contact our support organization.
277(2)	Communication error	Contact our support organization.
278	Internal device error	Contact our support organization.

Cyclical Profisafe status message

Bit	Description	Measures/rectifying errors
0	Reserved	-
1	Error in F-Device or F-Module	Device is passivated (ON LED flashes). You will find information on de-passivating in the manual for your control system.
2	Communication error, CRC error	Device is passivated (ON LED flashes). You will find information on de-passivating in the manual for your control system.
3	Communication error, watchdog timeout	Device is passivated (ON LED flashes). You will find information on de-passivating in the manual for your control system.
4	Fail-safe values activated	-
5	Toggle bit	-
6	Consecutive number was reset	-
7	Reserved	-

11. Technical data



NOTICE

If a product data sheet is included with the product, the information on the data sheet applies in case of discrepancies with the operating instructions.

Parameter	Value
Housing material	Fiber glass reinforced plastic Die-cast zinc, nickel-plated, stainless steel, powder-coated sheet steel
Dimensions	See dimension drawing
Weight MGB-B-...-CB with mounting plate	1.9 kg
Ambient temperature	-20 ... +55 °C
Degree of protection	IP54
Safety class	III
Degree of contamination	3
Installation orientation	Any
Connection options, power supply	2 x push-pull power ¹⁾
Connection, bus	2 x RJ 45, push-pull, acc. to IEC 61076-3-117, variant 14, screened ¹⁾
Connecting cable, bus	Profinet I/O cable, at least cat. 5e
Operating voltage U _B	DC 24V +10% / -15% (PELV – see electrical connection)
Current consumption, max.	500 mA
Max. feed-in current in the connection block (push-pull plug connector)	4,000 mA
Fuse protection for power supply, external	Min. 0.7 A slow-blow
Rated insulation voltage U _i	75 V
Rated impulse withstand voltage U _{imp}	0.5 kV
Resilience to vibration and shock	Acc. to EN 60947-5-3
EMC protection requirements	Acc. to EN 61000-4 and DIN EN 61326-3-1
Risk times, max. (turn-off times) ²⁾ - Operating mode selector	220 ms
Reliability values acc. to EN ISO 13849-1	
Category	4 (EN 13849-1:2008-12)
Performance Level	PL e (EN 13849-1:2008-12)
MTTF _D ³⁾	91 years
DC	99%
Mission time	20 years
PFH _D ³⁾	4.1 x 10 ⁻⁸ / h

¹⁾ The document *PROFINET Cabling and Interconnection Technology* from the PNO aids in the correct selection of cables.

²⁾ The risk time is the max. time between the change in the input status and the clearing of the corresponding bit in the bus protocol.

³⁾ Fixed failure rate without consideration of faults in wearing parts.

⁴⁾ Information regarding wearing parts without consideration of fixed failure rates in electronic components.

12. Troubleshooting

Refer to the enclosed data sheet for detailed instructions on troubleshooting.

13. Service

If servicing is required, please contact:

Euchner GmbH + Co. KG
Kohlhammerstraße 16
70771 Leinfelden-Echterdingen
Germany

Service telephone:
+49 711 7597-500

E-mail:
support@euchner.de

Internet:
www.euchner.com

14. Inspection and service



WARNING

Loss of the safety function because of damage to the device.
In case of damage, the affected module must be replaced completely. Only accessories or spare parts that can be ordered from Euchner may be replaced.

Regular inspection of the following is necessary to ensure trouble-free long-term operation:

- › Check the switching function
- › Check the secure mounting of the devices and the connections
- › Check for soiling

No servicing is required. Repairs to the device are only allowed to be made by the manufacturer.



NOTICE

The year of manufacture can be seen in the lower right corner of the rating plate.

15. Replacement of the system

See section "Automatic assembly replacement" in the control system manual.

16. Declaration of conformity

More than safety.



EUCHNER

EUCHNER GmbH + Co. KG
Kohlhammerstraße 16
70771 Leinfelden-Echterdingen
Germany

EG-Konformitätserklärung
EC-Declaration of Conformity
CE-Déclaration de Conformité
CE-Dichiarazione di conformità
CE-Declaración de conformidad

Original DE
Translation EN
Traduction FR
Traduzione IT
Traducción ES

123624-01-01/15

Die nachfolgend aufgeführten Produkte sind konform mit den Anforderungen der folgenden Richtlinien (falls zutreffend):
The beneath listed products are in conformity with the requirements of the following directives (if applicable):
Les produits mentionnés ci-dessous sont conformes aux exigences imposées par les directives suivantes (si valable)
I prodotti sotto elencati sono conformi alle direttive sotto riportate (dove applicabili):
Los productos listados a continuación son conforme a los requisitos de las siguientes directivas (si fueran aplicables):

I:	2006/42/EG	Maschinenrichtlinie
	2006/42/EC	Machinery directive
	2006/42/CE	Directive Machines
	2006/42/CE	Direttiva Macchine
	2006/42/CE	Directiva de máquinas

Die Schutzziele der Niederspannungsrichtlinie wurden gemäß Anhang I, Nr. 1.5.1 der Maschinenrichtlinie eingehalten.
The safety objectives of the Low-Voltage Directive comply with Annex I, No. 1.5.1 of the Machinery Directive.
Les objectifs de sécurité de la Directive Basse Tension sont conformes à l'annexe I, No. 1.5.1 de la Directive Machines
Gli obiettivi di sicurezza della Direttiva Bassa Tensione sono conformi a quanto riportato all'allegato I, No. 1.5.1 della Direttiva Macchine.
Los objetivos de seguridad de la Directiva de Bajo Voltaje cumplen con el Anexo I, No. 1.5.1 de la Directiva de Máquinas

Folgende Normen sind angewandt:
Following standards are used:
Les normes suivantes sont appliquées:
Vengono applicate le seguenti norme:
Se utilizan los siguientes estándares:

a:	EN 60947-5-3:1999 + A1:2005
b:	EN ISO 14119:2013
c:	EN ISO 13849-1:2008
d:	EN 61784-3-3:2008 (Profisafe)

Bezeichnung der Bauteile <i>Description of components</i> <i>Description des composants</i> <i>Descrizione dei componenti</i> <i>Descripción de componentes</i>	Type <i>Type</i> <i>Type</i> <i>Tipo</i> <i>Typo</i>	Richtlinie <i>Directives</i> <i>Directive</i> <i>Direttiva</i> <i>Directivas</i>	Normen <i>Standards</i> <i>Normes</i> <i>Norme</i> <i>Estándares</i>	Zertifikats-Nr. <i>No. of certificate</i> <i>Numéro du certificat</i> <i>Numero del certificato</i> <i>Número del certificado</i>
---	--	--	--	---

Sicherheitsschalter <i>Safety Switches</i> <i>Interrupteurs de sécurité</i> <i>Fincorsa di sicurezza</i> <i>Interruptores de seguridad</i>	MGB...PN ...	I	a, b, c, d	Z10 10 04 40393 008
--	--------------	---	------------	---------------------

Benannte Stelle <i>Notified Body</i> <i>Organisme notifié</i> <i>Sede indicata</i> <i>Entidad citada</i>	NB 0123 TÜV SÜD Product Service GmbH Ridlerstrasse 65 80339 München Germany
--	---

Leinfelden, Januar 2015

EUCHNER GmbH + Co. KG
Kohlhammerstraße 16
70771 Leinfelden-Echterdingen
Germany

i.A. Dipl.-Ing. Richard Holz
Leiter Elektronik-Entwicklung
Manager Electronic Development
Responsable Développement Électronique
Direttore Sviluppo Elettronica
Director de desarrollo electrónico

i.A. Dipl.-Ing. (FH) Duc Binh Nguyen
Dokumentationsbevollmächtigter
Documentation manager
Responsable documentation
Responsabilità della documentazione
Agente documenta

Euchner GmbH + Co. KG
Kohlhammerstraße 16
70771 Leinfelden-Echterdingen
Germany
info@euchner.de
www.euchner.com

Edition:
2124005-04-02/21
Title:
Operating Instructions Safety Systems
MGB-B...-PN (PROFINET) and
With Data Structure Type C (Expanded) From V 3.30.1
(translation of the original operating instructions)
Copyright:
© Euchner GmbH + Co. KG, 02/2021

Subject to technical modifications; no responsibility is accepted for the accuracy of this information.