

EUCHNER

Operating Instructions

**Safety Relay with IO-Link
for emergency stop, safety door and light grid monitoring
ESM-CB**

EN

Contents

1.	About this document	4
1.1.	Scope.....	4
1.2.	Target group	4
1.3.	Key to symbols.....	4
1.4.	Supplementary documents	4
2.	Correct use	5
3.	Description of the safety function	6
3.1.	Monitoring of sensor circuits	6
3.2.	Starting behavior	6
4.	Exclusion of liability and warranty	7
5.	General safety precautions	7
6.	Function	8
6.1.	IO-Link communication and functions	8
6.1.1.	Enabling from the non-safety-related control system.....	8
6.1.2.	Chain reset.....	8
6.2.	Block diagram	9
6.2.1.	Insulation coordination.....	9
6.3.	Communication and functions with BR safety switches.....	10
6.3.1.	Diagnostic data.....	10
6.3.2.	Hot plugging – replacing a BR safety switch	10
6.4.	Function of monitoring output OM	10
7.	Mounting	11
8.	Electrical connection	12
8.1.	Terminal assignment	13
8.2.	Signaling device connection variants	14
8.2.1.	Sensor circuit S1	14
8.2.2.	Sensor circuit S2	14
8.3.	Start circuit and feedback loop connection variants	15
8.4.	Notes about 	16
9.	Application example	16
9.1.	Dual-channel monitoring of emergency-stop pushbutton and safety switch chain with IO-Link	16
10.	Setup	18
11.	Calculating the power dissipation	19
12.	Function test	20

13.	Device diagnostics	21
13.1.	Diagnostics via LED displays	21
13.1.1.	General states	21
13.1.2.	Error messages.....	22
14.	IO-Link communication and diagnostic data	23
14.1.	Device description file	23
14.1.1.	Overview of IODDs	23
14.1.2.	Use of the various IODDs.....	23
14.2.	Process-data structure and addressing	24
14.3.	Cyclical data (process data).....	24
14.3.1.	Input data.....	24
14.3.2.	General description of the process data	25
14.3.3.	Output data	25
14.4.	Acyclical data (device data and events).....	26
14.4.1.	Writing and reading services	26
14.5.	Communication with BR devices.....	28
14.6.	Error table for BR devices	29
15.	Technical data	30
15.1.	Safety relay ESM-CB	30
15.2.	Function and time diagrams.....	35
15.2.1.	Time diagram for automatic start.....	35
15.2.2.	Time diagram for manual, monitored start	35
15.3.	Derating.....	36
15.3.1.	Vertical or horizontal installation orientation.....	36
15.4.	Load curve.....	36
15.4.1.	Resistive and inductive loads	36
16.	Ordering information and accessories	37
17.	Inspection and service	37
18.	Service	38
19.	Declaration of conformity	39

1. About this document

1.1. Scope





This document is valid for:

- › Safety Relay with IO-Link for emergency stop, safety door and light grid monitoring ESM-CB

1.2. Target group





Design engineers and installation planners for safety devices on machines, as well as setup and servicing staff possessing special expertise in handling safety components. These persons must also be familiar with the safety concept underlying this customer-specific solution.

1.3. Key to symbols

Symbol/depiction	Meaning
	Printed document
	Document is available for download at www.euchner.com
	Document on CD
 DANGER WARNING CAUTION	Safety precautions Danger of death or severe injuries Warning about possible injuries Caution slight injuries possible
 NOTICE Important!	Notice about possible device damage Important information
Tip	Useful information

1.4. Supplementary documents

The overall documentation for this device consists of the following documents:

Document title (document number)	Contents	
Safety information and maintenance for safety relay ESM-CB (2522723)	Basic information for safe setup and service	
Operating instructions for safety relay ESM-CB (2522722)	(this document)	
Possibly enclosed data sheet	Item-specific information about deviations or additions	
	Important! Always read all documents to gain a complete overview of safe installation, setup and use of the device. The documents can be downloaded from www.euchner.com . For this purpose enter the doc. no. in the search box.	

2. Correct use

The safety relay is used to monitor safety-related signaling devices and to control actuators. The safety circuit monitors two sensor circuits. Each sensor circuit can have one or two channels. When at least one sensor circuit is interrupted, the safety relay initiates the safe state. The safety relay interrupts safety circuits in a safety-related manner.

Possible signaling devices:

- › Emergency stop pushbuttons
- › Safety door interlocks
- › Light grids

Before use, a risk assessment must be performed on the machine, e.g. in accordance with:

- › EN ISO 13849-1, Safety of machinery – Safety-related parts of control systems – Part 1: General principles for design
- › EN ISO 12100, Safety of machinery – General principles for design – Risk assessment and risk reduction
- › EN IEC 62061, Safety of machinery – Functional safety of safety-related electrical, electronic and programmable electronic control systems

Correct use includes observing the relevant requirements for installation and operation, e.g.:

- › EN ISO 13849-1, Safety of machinery – Safety-related parts of control systems – Part 1: General principles for design
- › EN 60204-1, Safety of machinery – Electrical equipment of machines – Part 1: General requirements



Important!

- › The user is responsible for the proper integration of the device into a safe overall system. For this purpose, the overall system must be validated, e.g. in accordance with EN ISO 13849-2.
- › Correct use requires observing the permissible operating parameters (see chapter 15. *Technical data*).
- › Only components that are intended for combination with the device may be used. Also observe the operating instructions for the components used (see chapter 1.4. *Supplementary documents*)

3. Description of the safety function

3.1. Monitoring of sensor circuits

The safety circuit monitors two sensor circuits. Each sensor circuit can have one or two channels.

The safety relay can be operated only if both sensor circuits are used. If only one sensor circuit is used, the second sensor circuit must be bridged.

The sensor circuits evaluate various signaling devices:

- **Sensor circuit S1** with short circuit detection; suitable for single- or dual-channel safety sensors
- **Sensor circuit S2** suitable for OSSD signals; short circuit detection by signaling device

See chapter 6.2. *Block diagram.*

Single-channel sensor circuit

- The sensor circuit is not redundant.
- The safety relay does not detect short circuits in the sensor circuit.

Dual-channel sensor circuit

- The dual-channel sensor circuit is connected equivalently.
- The safety relay detects short circuits in the sensor circuit when wired accordingly.

See chapter 8.2. *Signaling device connection variants.*

3.2. Starting behavior

Start conditions

- Both sensor circuits are closed
- Enable signal present

The enable signal is a signal sent from the control system via IO-Link.

See chapter 6.1.1. *Enabling from the non-safety-related control system.*

Automatic start

The device starts automatically when the start conditions are met.

Manual, monitored start

When the start conditions are met, the device starts after the start circuit has been closed and then opened again by the start button being pressed and released.

A connected start button is monitored.

See chapter 8.3. *Start circuit and feedback loop connection variants.*

Safe shut-down

Safety contacts 13/14 and 23/24 open without delay when at least one sensor circuit is interrupted.

The device is in the safe state when the safety contacts are open.

4. Exclusion of liability and warranty

In case of failure to comply with the conditions for correct use stated above, or if the safety regulations are not followed, or if any servicing is not performed as required, liability will be excluded and the warranty void.

5. General safety precautions



WARNING

Danger to life due to improper installation or due to bypassing (tampering). Safety components fulfill a personnel protection function.

- Mounting, electrical connection and setup only by authorized personnel possessing the following knowledge:
 - specialist knowledge in handling safety components
 - knowledge about the applicable EMC regulations
 - knowledge about the applicable regulations on operational safety and accident prevention.
- The number of teach-in and switching operations is saved in the internal memory of the evaluation unit. If necessary, this memory can be read by the manufacturer.



Important!

Prior to use, read the operating instructions and keep these in a safe place. Ensure the operating instructions are always available during mounting, setup and servicing. EUCHNER cannot provide any warranty in relation to the readability of the CD for the storage period required. For this reason you should archive a printed copy of the operating instructions. You can download the operating instructions from www.euchner.com.

6. Function

6.1. IO-Link communication and functions

The safety relay is an IO-Link device.

Communication via IO-Link offers cyclical (process data) and acyclical (device data and events) data exchange.



Important!

The cyclical and acyclical data can be found in chapter 14. *IO-Link communication and diagnostic data.*

The following information is transmitted:

- › Device information of the safety relay (electronic rating plate, states of the device)
- › State information about connected BR safety switches

IO-Link communication can be used for the following functions as well:

- › Enable signal: non-safety-related signal for controlling the safety contacts of the safety relay
- › Chain reset: performing a reset of the BR safety switch chain

6.1.1. Enabling from the non-safety-related control system

The safety contacts of the safety relay can be controlled via a non-safety-related enable signal via IO-Link communication. The start button does not have to be pressed again.

When the safety relay detects an IO-Link connection, the enable signal must be set accordingly via IO-Link communication for operation.

This function is not relevant to safety and is subordinate to the safety engineering function of the safety relay. In other words, the non-safety-related enable signal cannot start the safety contacts of the safety relay until the safety-relevant prerequisites for sensor circuits and the starting circuit of the safety relay have been fulfilled.

The enable signal is controlled via cyclical data exchange (process data).

6.1.2. Chain reset

All BR safety switches in a chain can be centrally restarted with a chain reset via IO-Link communication.

This function facilitates the re-establishment of readiness after troubleshooting.

The chain reset command is controlled via cyclical data exchange (process data).

6.2. Block diagram

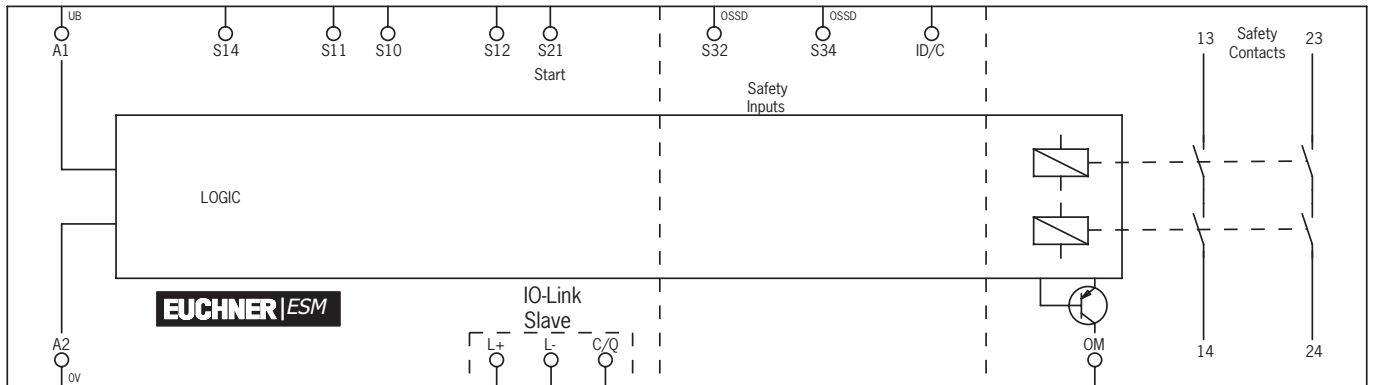

Figure 1: Block diagram

A1	Power supply 24 V DC
A2	Power supply 0 V
S10	Supply input for S14
S11	Supply output for S12 and S21
S12	Sensor circuit S1 input (channel 1)
S14	Sensor circuit S1 input (channel 2)
S21	Start circuit
S32	OSSD sensor circuit S2 input (channel 1)
S34	OSSD sensor circuit S2 input (channel 2)
13/14 23/24	Safety contacts, non-time-delay
ID/C	Safety switch diagnostic input
OM	Digital monitoring output
L+/L-	IO-Link supply
C/Q	IO-Link switching and communication line

6.2.1. Insulation coordination



WARNING

Loss of electrical safety

- Take measures outside the device to limit transient overvoltages to the respective value for over-voltage category II.

	A1/A2, Logic	IO-Link	13/14	23/24	Housing
A1/A2, Logic	-	0.5 kV ST	4 kV ST	4 kV ST	4 kV BI
IO-Link	-	-	4 kV ST	4 kV ST	4 kV BI
13/14	-	-	-	4 kV ST	4 kV BI
23/24	-	-	-	-	4 kV BI
Housing	-	-	-	-	-

Key:

- BI** Basic insulation
- ST** Safe isolation
- Logic** Sensor and start circuits, diagnostic input monitoring output
- IO-Link** IO-Link supply, IO-Link switching and communication line

6.3. Communication and functions with BR safety switches

6.3.1. Diagnostic data

The ID/C connection of the safety relay allows the diagnostic line of a BR safety switch chain to be connected.

The ID/C connection represents a non-safety-related communication channel between the safety relay and the safety switches.

The switches address the individual switches when the safety switch chain starts up. Addressing permits unique diagnostics for each safety switch.

The safety relay synchronizes itself with the safety switch chain after a restart. All safety switches are then available for communication and diagnostics. The safety contacts can be enabled only after establishment of complete BR communication.

6.3.2. Hot plugging – replacing a BR safety switch

A safety switch within a BR safety switch chain can be replaced during operation. This process is called *hot plugging*.

In order to perform correct addressing after replacement, only one safety switch can be replaced at a time (1:1 replacement).

If another safety switch is to be replaced, the required switch-on delay of the previously replaced switch must be taken into account.



Important!

Observe the technical data of the BR safety switch in the corresponding product documentation.

6.4. Function of monitoring output OM

The signal level of the monitoring output is equivalent to the state of the safety relay's safety contacts.

The monitoring output is active (HIGH level) when the safety contacts are closed.

The monitoring output is inactive (LOW level) when at least one safety contact is open.

7. Mounting



NOTICE

Device damage due to improper installation or unsuitable ambient conditions.

- The safety relay must be installed in a control cabinet protected against dust and moisture, with a minimum degree of protection of IP54. A snap-in element on the rear of the device is used for fastening to a mounting rail.
- When mounting several evaluation units side by side in a control cabinet without air circulation (e.g. fan), note that a minimum distance of 10 mm must be maintained between the evaluation units. This distance enables the heat from the evaluation unit to dissipate. Observe the derating in chapter 15.3.

- Mount the device on a 35-mm mounting rail according to EN 60715.
- Loosen the locking foot using a screwdriver to remove.

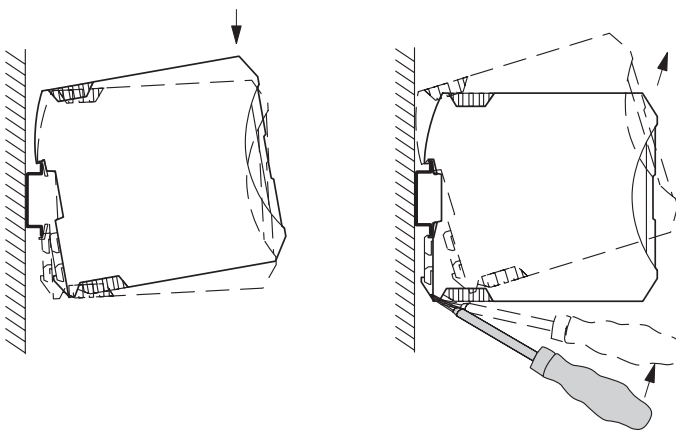

Figure 2: Mounting and removing

8. Electrical connection



WARNING

- If there is a mistake, loss of the safety function due to incorrect connection.
- › Monitoring outputs must not be used as safety outputs.
 - › Lay the connecting cables with protection to prevent the risk of short circuits.



NOTICE

- Risk of damage to equipment or malfunctions as a result of incorrect connection.
- › All the electrical connections must either be isolated from the mains supply by a safety transformer according to IEC 61558-2-6 with limited output voltage in the event of a fault, or by other equivalent isolation measures.
 - › All electrical outputs must have an adequate protective circuit for inductive loads. The outputs must be protected with a free-wheeling diode for this purpose. The switch-on current may have to be limited for capacitive loads.
 - › Protect the 24 V area with a suitable external fuse.
 - › Make sure that the power supply unit can provide quadruple the nominal current of the external fuse in order to guarantee reliable triggering in case of a fault.

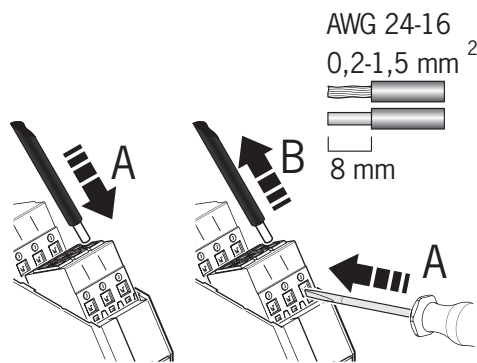



Figure 3: Cable connection (spring terminal)



Tip!

- › It is recommended to use cable end sleeves for connecting flexible cables

8.1. Terminal assignment

A1	A2	S21
S11	S12	S14
S10	S32	S34
<input type="checkbox"/> DIA <input type="checkbox"/> PWR <input type="checkbox"/> STATE1 <input type="checkbox"/> STATE2 <input type="checkbox"/> K1/K2 <input type="checkbox"/> IO-Link		
 		
13	14	23
ID/C	OM	24
C/Q	L+	L-

A1	Power supply 24 V DC
A2	Power supply 0 V
S10	Supply input for S14
S11	Supply output for S12 and S21
S12	Sensor circuit S1 input (channel 1)
S14	Sensor circuit S1 input (channel 2)
S21	Input for start circuit
S32	OSSD sensor circuit S2 input (channel 1), input for FO1A from BR series connection
S34	OSSD sensor circuit S2 input (channel 2), input for FO1B from BR series connection
PWR	Power LED (green, yellow, red)
DIA	Diagnostic message present indication; LED (red)
IO-Link	IO-Link communication status indication; LED (green)
STATE 1	Sensor circuit S1 status indication; LED (green)
STATE 2	Sensor circuit S2 status indication; LED (green)
K1/K2	Safety circuit K1 and K2 status indication; LED (green)
13/14	Safety contact, non-time-delay
23/24	Safety contact, non-time-delay
ID/C	Safety switch diagnostic input
OM	Digital monitoring output
C/Q	IO-Link switching and communication line
L+/L-	IO-Link supply

8.2. Signaling device connection variants



Important!

The safety relay can be operated only if both sensor circuits are used. If only one sensor circuit is used, the second sensor circuit must be bridged.

8.2.1. Sensor circuit S1



WARNING

Danger due to the machine restarting automatically

▸ Low-resistance PLC outputs can be interpreted as a permanent High signal (permanently switched on) at input S14 of the safety relay. Safe shut-down via a low-resistance PLC output at S14 is therefor not possible.

- Do not use any low-resistance PLC outputs at input S14.

▸ Connect suitable signaling devices to S11/S12/S10/S14.

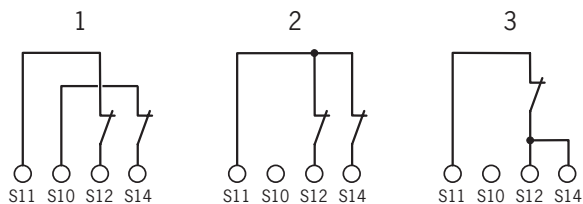

Figure 4: Sensor circuit S1 connection variants

Key:

- 1 Dual-channel connection with short-circuit detection
- 2 Dual-channel connection without short-circuit detection
- 3 Single-channel connection

8.2.2. Sensor circuit S2



Important!

Sensor circuit S2 does not offer short circuit detection. If short-circuit detection is required, this must be performed externally by means of suitable signaling devices.

▸ Connect suitable signaling devices to S32/S34.

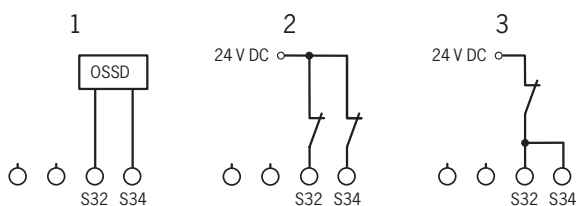

Figure 5: Sensor circuit S2 connection variants

Key:

- 1 Dual-channel connection with **external** short circuit detection by the signaling device
- 2 Dual-channel connection without short-circuit detection
- 3 Single-channel connection

8.3. Start circuit and feedback loop connection variants



WARNING

Danger due to the machine restarting automatically

- When the manual reset function is used with monitored starting, a short circuit between A2/S21/0 V can the cable of the start button can cause the machine to start up automatically. This applies in particular to safety functions with a high risk potential.
 - Rule out a short circuit between A2/S21/0 V and the cable from the start button to S21 by design measures (see fault exclusion according to EN ISO 13849-2).
- Low-resistance PLC outputs can be interpreted as a ground signal at input S21 of the safety relay and can cause an automatic start.

Automatic start

- Bridge contacts S10/S21.

Manual, monitored start

- Connect a start button to S11/S21.

A connected start button is monitored.

Start circuit and feedback loop

- To monitor external contactors or expansion devices with positively driven contacts, place the respective NC contacts in the path S10/S21 or S11/S21.

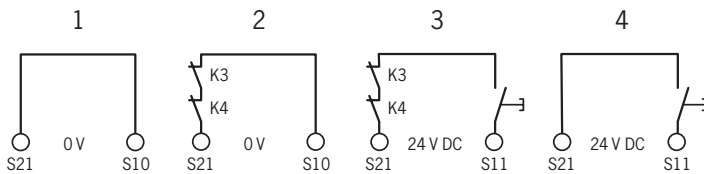

Figure 6: Start circuit and feedback loop connection variants

Key:

- 1** Automatic start
- 2** Automatic start with monitored contact expansion
- 3** Manual, monitored start with monitored contact expansion
- 4** Manual, monitored start

8.4. Notes about



Important!

- › For use and operation as per the  requirements ¹⁾, a power supply with the feature “for use in class 2 circuits” must be used.
Alternative solutions must comply with the following requirements:
 - Electrically isolated power supply unit with a max. open-circuit voltage of 30 V/DC and a limited current of max. 8 A.
- › Use cable material made of copper with a temperature resistance of 60° C/75 °C.

1) Note on the scope of the UL approval: the devices have been tested as per the requirements of UL508 and CSA/ C22.2 no. 14 (protection against electric shock and fire).

9. Application example

9.1. Dual-channel monitoring of emergency-stop pushbutton and safety switch chain with IO-Link



WARNING

- Loss of functional safety
- › Make sure that the signaling device and the safety relay have the same ground potential.



Important!

Observe the information about applications with BR safety switches in the corresponding product documentation.

Description of the application:

- › Dual-channel emergency-stop monitoring on sensor circuit S1
- › Dual-channel monitoring of the safety switch chain on sensor circuit S2
- › Manual, monitored start of the safety relay by start relay S1 (connection S21)
- › Monitoring of external, positively driven contactors in the start circuit at S21
- › IO-Link connection of the safety relay to the IO-Link master

Achievable safety integrity:

- › Suitable up to category 4, PL e (EN ISO 13849-1), SIL 3 (EN 62061)

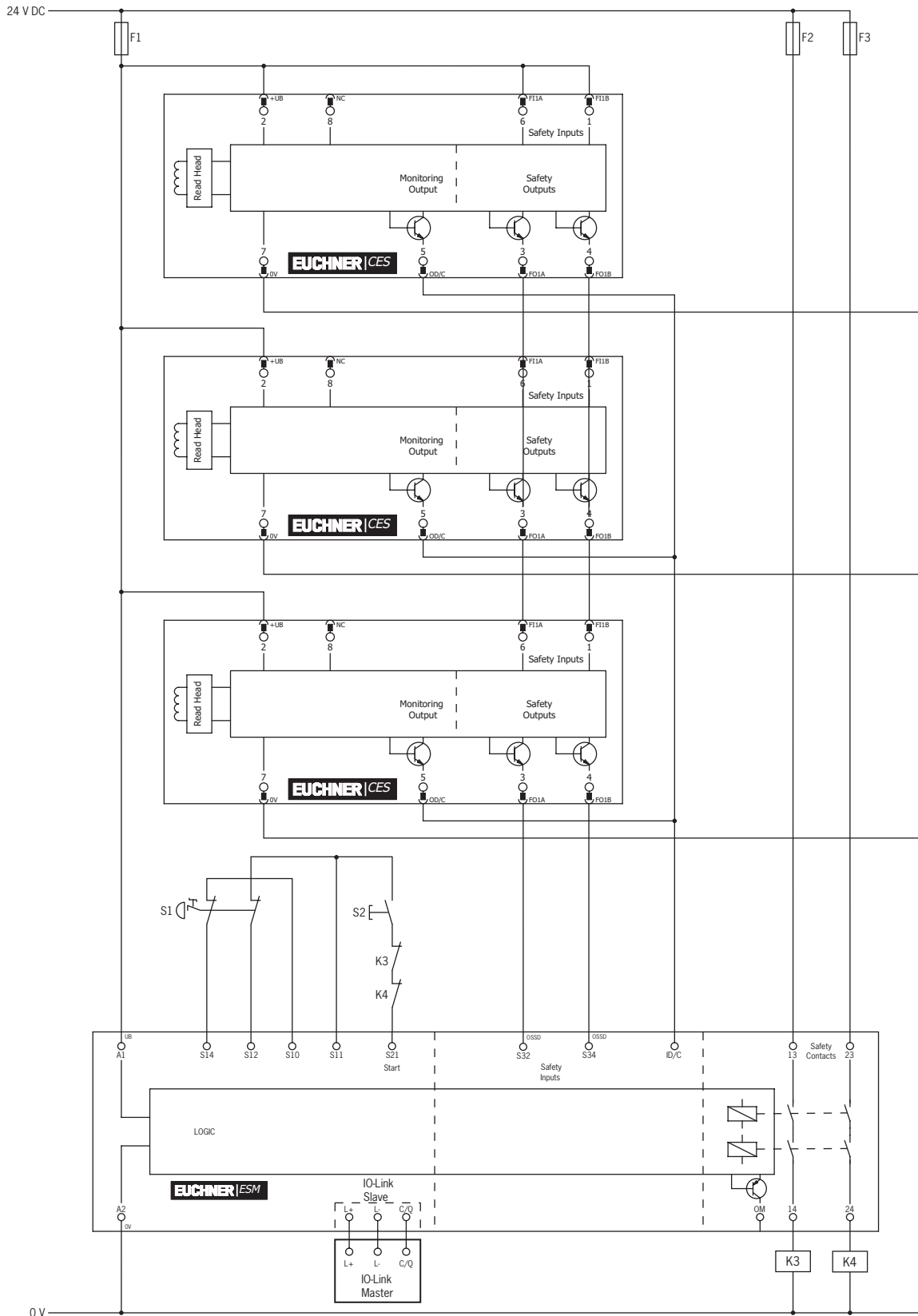

Figure 7: Monitoring of emergency-stop pushbutton and safety switch chain with IO-Link

Key:	
S1	Emergency stop pushbutton
S2	Manual resetting device
S3 ... S5	BR safety switch
F1 ... F3	External fuses
K3/K4	Positively driven contactors

10. Setup



WARNING

- In emergency stop applications, automatic machine startup can pose a severe danger to the operator.
 - Prevent the machine from being started up again automatically by the higher-level control system.
- According to EN ISO 13849-1, the manual, monitored resetting device must not trigger a machine start.
- Inductive loads can lead to welded relay contacts.
 - Implement suitable, effective suppressor circuits on inductive loads.
 - Connect the suppressor circuits in parallel with the load, not in parallel with the switching contact.
- Magnetic fields can affect the device.
 - The magnetic field strength in the surroundings must not exceed 30 A/m.
 - Do not use the device near strong magnetic fields (e.g. due to transformers or magnetite).
- Interference can be emitted during the operation of relay modules. Radio reception in residential areas can be disturbed.
The device is a class-A product.
 - Observe the requirements for emitted interference for electrical and electronic equipment (EN 61000-6-4).
 - Take appropriate protective measures against emitted interference.

Integrating the device description file

- Integrate the suitable device description file (IODD) into the engineering tool in accordance with the number of connected BR safety switches (see chapter 14.1. *Device description file*).
- Download the configuration to the IO-Link master.

Setting up the safety relay

- Connect the power supply (24 V DC) to terminals A1/A2.
- Connect the IO-Link supply L+/L- and the switching and communication cable C/Q to the corresponding port of the IO-Link master.
 - ➔ The PWR LED illuminates green.
 - ➔ The IO-Link LED flashes green once IO-Link communication has been established.
- Connect the sensor circuits in accordance with their wiring (see chapter 8.2. *Signaling device connection variants*).

Activating the enable signal

- To control the safety contacts, set the enable signal via the cyclical data item in byte 0, bit 0 (see chapter 14.3. *Cyclical data (process data)*).

Automatic start

- ➔ Close safety contacts 13/14 and 23/24.
- ➔ LED K1/K2 illuminates green.

Manual, monitored start

- Press the start button.
- Release the start button.
 - ➔ Close safety contacts 13/14 and 23/24.
 - ➔ LED K1/K2 illuminates green.

Possible diagnoses

The status information of the individual BR safety switches and the device information of the safety relay can be processed by the cyclical data (see chapter 14.3. *Cyclical data (process data)*).

11. Calculating the power dissipation



Important!

The total power dissipation of the safety relay results from the input power dissipation and the contact power dissipation with equal or differing load currents.

Input power dissipation

$$P_{\text{input}} = U_B^2 / (U_S / I_S)$$

$$P_{\text{IO-Link}} = U_{\text{BIOL}}^2 / (U_{\text{IOL}} / I_{\text{IOL}})$$

Contact power dissipation

With equal load currents:

$$P_{\text{contact}} = n * I_L^2 * 50 \text{ m}\Omega$$

With differing load currents:

$$P_{\text{contact}} = (I_{L1}^2 + I_{L2}^2) * 50 \text{ m}\Omega$$

Total power dissipation

$$P_{\text{total}} = P_{\text{input}} + P_{\text{IO-Link}} + P_{\text{contact}}$$

therefore

$$P_{\text{total}} = U_B^2 / (U_S / I_S) + U_{\text{BIOL}}^2 / (U_{\text{IOL}} / I_{\text{IOL}}) + n * I_L^2 * 50 \text{ m}\Omega$$

or

$$P_{\text{total}} = U_B^2 / (U_S / I_S) + U_{\text{BIOL}}^2 / (U_{\text{IOL}} / I_{\text{IOL}}) + (I_{L1}^2 + I_{L2}^2) * 50 \text{ m}\Omega$$

Key:

P	Power dissipation in mW
U_B	Connected operating voltage at A1 and A2
U_S	Rated control circuit supply voltage
I_S	Rated control supply current
U_{BIOL}	Connected IO-Link periphery supply voltage
U_{IOL}	IO-Link rated periphery supply voltage
I_{IOL}	IO-Link port supply current consumption
n	Number of safety contacts used
I_L	Contact load current

12. Function test



WARNING

Loss of functional safety due to malfunction.

- › Proper function of the device can no longer be ensured if the function test is faulty.
- Replace the device.

1. Switch on operating voltage.
2. Close all guards.
 - ➔ Automatic start: the machine can start.
 - ➔ Manual start: the machine may start only after you have pressed the start button.
3. Open the guard.
 - ➔ The machine must switch off and it must not be possible to start it as long as the guard is open.
4. Close the guard
 - ➔ Automatic start: the machine can start.
 - ➔ Manual start: the machine may start only after you have pressed the start button.

Repeat steps 2 ... 4 separately for each guard.

13. Device diagnostics



Important!

- › Plausibility errors are deleted when the power supply is switched off (power-down reset).
- › Please contact EUCHNER if an error or fault symptom that is not listed occurs.

13.1. Diagnostics via LED displays



Important!

Behavior of the IO-Link LED

- › In the operating state with IO-Link, the IO-Link LED flashes green while IO-Link communication is active.
- › If the IO-Link LED is switched off in the operating state with IO-Link, this indicates a loss of communication. Check the IO-Link connection in this case.

13.1.1. General states

No.	Status	LEDs						State
		DIA red	PWR green	STATE 1 green	STATE 2 green	K1/K2 green	IO-Link green	
1	PowerUp	○	☀	☀ 5 Hz	○	○	○	Device booting.
2	Ready	○	☀	○	○	○	X	All relays not controlled. All sensor circuits are off.
		○	☀	☀ Long ON, short OFF	○	○	X	All relays not controlled. Sensor circuit 2 is off.
		○	☀	○	☀ Long ON, short OFF	○	X	All relays not controlled. Sensor circuit 1 is off.
3	Ready for switching on	○	☀	☀ Long ON, short OFF	☀ Long ON, short OFF	○	X	One or both sensor circuits (S1 and S2) is or are active. Relays K1 and K2 are ready to start and waiting for a start command.
4	Safety outputs On	○	☀	☀	☀	☀	X	The sensor circuits are active. All relays have picked up.

Key:

○	LED off
☀	LED illuminated
☀ 5 Hz	LED flashes at 5 Hz
X	State-dependent

13.1.2. Error messages

No.	Status	LEDs						State
		DIA red	PWR green	STATE 1 green	STATE 2 green	K1/K2 green	IO-Link green	
5	Internal error	☀	☀	○	○	○	○	Module is not ready for operation.
6	Input error at S1	☀	☀	☀ 2x	○	○	X	External error: The channel 1 sensor circuit was opened and reactivated, e.g. discrepancy error.
7	Input error at S2	☀	☀	○	☀ 2x	○	X	External error: The channel 2 sensor circuit was opened and reactivated, e.g. discrepancy error.
8	Start button error	☀	☀	☀ 2x	☀ 2x	○	X	Error in manual reset S34.
9	Output error	☀	☀	☀	☀	☀ 4x	X	External error: The read-back contact in the start circuit is open. Internal error: 1. Diagnostic contact does not work properly. 2. NO contact is fused closed.
10	Periphery error	☀	☀	○	○	○	☀ 5x	L+ low voltage.
11	Periphery error	☀	☀	☀ 5x	○	○	X	Supply (A1/A2) low voltage.
12	BR communication error	☀	☀	○	☀	○	X	Check the ID/C or OD/C connection of the devices in the series connection.
13	BR communication error on one device	☀	☀	○	☀	○	X	Check the correct function of the device in the series connection.
17	Parameter error	☀	☀ 3x	○	○	○	○	Incorrect IO-Link parametrization.

Key:

○	LED off
☀	LED illuminated
☀ 3x	LED flashes three times
☀	Rapid flashing
X	State-dependent

14. IO-Link communication and diagnostic data

14.1. Device description file

Depending on the number of connected BR safety switches, you will require a corresponding device description file (IO-Link Device Description, IODD).

You can use the device description file to configure and set up IO-Link devices. It contains information about identification, device parameters, process and diagnostic data, communication properties and the design of the user interface in engineering tools

The valid device description files are available for download from the address www.euchner.com|service|download|software.

You additionally have the option of downloading the device description file from the official IO-Link page ioddfinder.io-link.com. Go to the *IODDfinder*.



Important!

If you selected an incorrect IODD or an IODD that offers too few inputs or outputs for your system design, your IO-Link configuration software will display a corresponding error message.

14.1.1. Overview of IODDs

Vendor ID		Device ID		Inputs	Outputs
hex	dec	hex	dec		
135	309	010101	65793	6	1
135	309	010102	65794	11	1
135	309	010103	65795	21	1
135	309	010104	65796	11	6
135	309	010105	65797	21	11
135	309	010106	65798	31	16

14.1.2. Use of the various IODDs

Different IODDs can be used depending on the length of a series connection. They differ in the number of process-data items on the input side and output side.

No outputs are required for series connections of interlocks, such as the CES-C07. Use the IODD that is the most suitable for the length of your chain.

Example: When connecting seven CES-C07 in series, use the IODD *Euchner-ESM_CB_158857_11x1-20181116-IODD1.1* for up to ten CES-C07 plus one byte for the evaluation unit. 8 bytes are used on the input side in this case.

14.2. Process-data structure and addressing

Refer to the following illustration and the associated table for the structure of the process data and for the addressing of a BR safety switch chain.

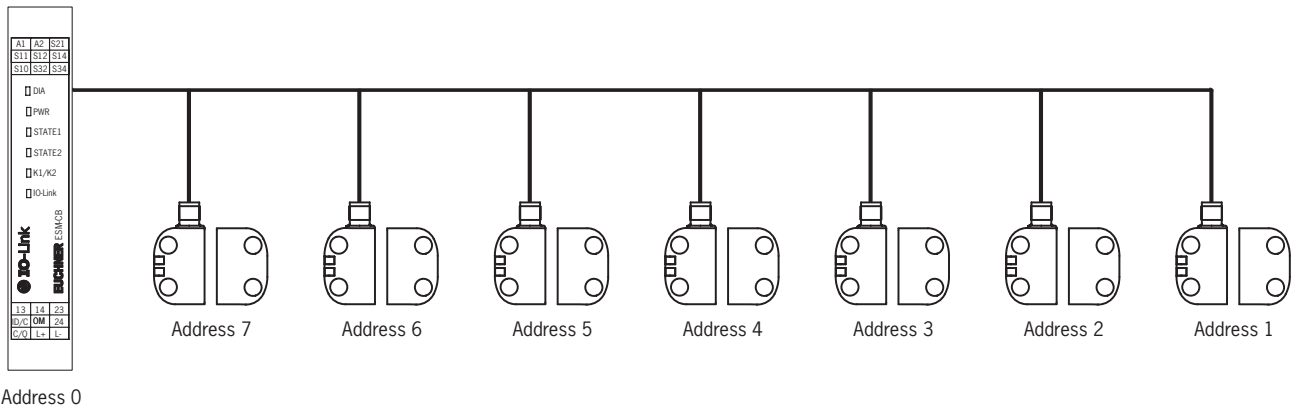

Figure 8: Addressing

Byte	0	1	2	3	4	5	6	7
Input process data	ESM-CB	Device 1 CES1	Device 2 CES2	Device 3 CES3	Device 4 CES4	Device 5 CES5	Device 6 CES6	Device 7 CES7
Output process data	ESM-CB	-	-	-	-	-	-	-

Example: 7 x CES

IODD *Euchner-ESM_CB_158857_11x1-20181116-IODD1.1* is used

Byte	0	1	2	3	4	5	6	7	8	9	10
Input I	ESM-CB	CES1	CES2	CES3	CES4	CES5	CES6	CES7	-	-	-
Output O	ESM-CB										

14.3. Cyclical data (process data)

Depending on the corresponding IODD, the device occupies 6/11/21/31 input process-data items and 1, 6, 11 or 16 output data items.

14.3.1. Input data

Byte 0 (IO-Link diagnostic bits/status of ESM-CB)

Bit	Description	Value
Bit 0	Sensor circuit S1	0: Sensor circuit S1 inactive
		1: Sensor circuit S1 active
Bit 1	Sensor circuit S2	0: Sensor circuit S2 inactive
		1: Sensor circuit S2 active
Bit 2	Output circuits K1 and K2	0: Output circuits K1 and K2 inactive
		1: Output circuits K1 and K2 active
Bit 3	Start circuit	0: No start acknowledgment required
		1: Start acknowledgment required
Bit 4 ... bit 7	Error messages	See device status and error messages

Device status and error messages



Important!

- › If several fault codes are active simultaneously, the error code with the highest priority will displace the other active error codes.
- › Error code 0000 *Ongoing operation* is permanently active.

Bit 4 ... bit 7	Description	Possible cause	Remedy
0111	System error	Internal error	Perform a power-down reset followed by a function test. Replace the device if the error recurs after the function test.
0110	Input error	Plausibility error in sensor circuit, short circuits	Check whether the second channel opens on request from the sensor.
		Internal error	Perform a power-down reset followed by a function test. Replace the device if the error recurs after the function test.
0101	IO-Link low voltage		Check the power supply.
0100	ESM-CB low voltage		Check the power supply.
0011	Diagnostic communication error	One or more safety switches cannot be reached.	Restart the safety switch chain
0010	Parameter error	Wrong manufacturer's code of a switch. Permanently configured process-data size insufficient.	Use only suitable BR safety switches. Remove the permanent configuration of the process-data size.
0001	Diagnostics active	Internal error	Perform a power-down reset followed by a function test. Replace the device if the error recurs after the function test.
0000	Ongoing operation	-	-

14.3.2. General description of the process data

Bit 7	Bit 6	Bit 5	Bit 4	Bit 3	Bit 2	Bit 1	Bit 0
OI	-	-	OR	OM	-	OW	OD

OI General error message

Retrieve the exact error code via an acyclical service.

OR State of the switch's predecessor

Indicates whether the preceding switch in the series connection has switched on the safety outputs.

OM State of the safety outputs of the switch

Indicates whether the switch has switched on the safety outputs.

OW Actuator weak area

When this bit is set, the actuator is at the edge of the detection area.

OD Door position

The bit is set when the guard is closed (it does not have to be locked).

Please refer to the manual of the connected interlocking device or guard locking device to determine which bits are actually used. Not all switches support every bit.

14.3.3. Output data

Byte 0 (IO-Link diagnostic bits/status of ESM-CB)

Bit	Description	Value
0	Enable signal	0: Deactivated (safety contacts blocked)
		1: Activated (safety contacts can be closed)
1	Chain reset	A chain reset is performed at the transition from 1 to 0
2 ... 7	Reserved	

14.4. Acyclical data (device data and events)

14.4.1. Writing and reading services



Important!

The manufacturer's code for EUCHNER is 0x01.

Index 100 – reading service: size of the input/output data areas

Index dec (hex)	Subindex dec (hex)	No.	Type	Description	
100 (64)	0 (0)	1 (1)	1	UInt8	Manufacturer's code of safety switch 1
			2	UInt8	Input process-data size of safety switch 1
			3	UInt8	Output process-data size of safety switch 1
		2 (2)	4	UInt8	Manufacturer's code of safety switch 2
			5	UInt8	Input process-data size of safety switch 2
			6	UInt8	Output process-data size of safety switch 2
	UInt8	...	
	31 (1F)	91	UInt8	Number of safety switches	

Index 101 – reading service: manufacturer's codes of the devices

Index dec (hex)	Subindex dec (hex)	No.	Type	Description	
101 (65)	0 (0)	1 (1)	1	UInt8	Manufacturer's code of safety switch 1
		2 (2)	2	UInt8	Manufacturer's code of safety switch 2
		UInt8	...
		30 (1E)	30	UInt8	Manufacturer's code of safety switch 30
		31 (1F)	31	UInt8	Number of safety switches

Index 102 – reading service: size of the input data area

Index dec (hex)	Subindex dec (hex)	No.	Type	Description	
102 (66)	0 (0)	1 (1)	1	UInt8	Input process-data size of safety switch 1
		2 (2)	2	UInt8	Input process-data size of safety switch 2
		UInt8	...
		30 (1E)	30	UInt8	Input process-data size of safety switch 30
		31 (1F)	31	UInt8	Number of safety switches

Index 103 – reading service: size of the output data area

Index dec (hex)	Subindex dec (hex)	No.	Type	Description	
103 (67)	0 (0)	1 (1)	1	UInt8	Output process-data size of safety switch 1
		2 (2)	2	UInt8	Output process-data size of safety switch 2
		UInt8	...
		30 (1E)	30	UInt8	Output process-data size of safety switch 30
		31 (1F)	31	UInt8	Number of safety switches

Index 201 ... 230 – writing service: command to individual switch



NOTICE

The possible telegrams are described in chapter 14.5. *Communication with BR devices.*

Index dec (hex)	Subindex dec (hex)	No.	Type	Description
201 (C9)	0 (0)	1	UInt8	User data length of the telegram for safety switch 1
		2 ... 8	UInt8	User data of the telegram for safety switch 1
202 (CA)	0 (0)	1	UInt8	User data length of the telegram for safety switch 2
		2 ... 8	UInt8	User data of the telegram for safety switch 2
...
230 (E6)	0 (0)	1	UInt8	User data length of the telegram for safety switch 30
		2 ... 8	UInt8	User data of the telegram for safety switch 30

The telegram consists of eight bytes for writing to the indices. The user data of the telegram therefore must be padded with 00.

Example:

01 02 00 00 00 00 00 00

01 = User data length

02 = Request telegram to the ESM-CB (order number/serial number)

Bytes 2 ... 7: padded zeros

Index 250 – writing service: IO-Link mode

Index dec (hex)	Subindex dec (hex)	No.	Type	Description
250 (FA)	0 (0)	1	UInt8	Reset of IO-Link mode 0x01 : reset IO-Link mode 0xFF : retain IO-Link mode

Index 10 ... 17 – reading service: retrieving the data of the ESM-CB

Index dec (hex)	Subindex dec (hex)	No.	Type	Description
16 (10)	0 (0)	-	String	Manufacturer
17 (11)	0 (0)	-	String	Manufacturer's text
18 (12)	0 (0)	-	String	Product name
19 (13)	0 (0)	-	String	Product ID
20 (14)	0 (0)	-	String	Product text
21 (15)	0 (0)	-	String	Serial number
22 (16)	0 (0)	-	String	Hardware version
23 (17)	0 (0)	-	String	Firmware version

14.5. Communication with BR devices

Note: The data is in Big Endian format.

Transmission			Reply	
Hex	Dec	Command	Number of bytes	Number of bytes
2	2	Send order no. and serial no.	3 bytes for order no.	3 bytes for serial no.
3	3	Send device version	1 byte for letter V	4 bytes for version number, e.g. 1.0.1.0 (the periods are not transmitted)
5	5	Send number of safety switches in the series connection	2 bytes	
12	18	Send current error code	1 byte for error code.	
13	19	Send saved error code (history)	1 byte for error code. This error is no longer present.	
14	20	Send size of log file	1 byte for length of the current log file	
15	21	Send entry from log file with index. The required index must be sent in the second byte.	1 byte for error code.	
16	22	Send current actuator code	With unicode evaluation: 5 bytes for code of the currently read actuator. With multicode evaluation: replies with 5x 0xFF	
17	23	Send taught-in actuator code	With unicode evaluation: 5 bytes for code of the taught-in actuator in the switch. With multicode evaluation: replies with 5x 0xFF	
18	24	Send disabled actuator code	With unicode evaluation: 5 bytes for code of the currently disabled actuator. With multicode evaluation: replies with 5x 0xFF	
19	25	Send applied voltage	2 bytes for voltage value in mV	
1A	26	Send current temperature	1 byte for temperature value in °C	
1B	27	Send number of switching cycles	3 bytes for counter value	
1D	29	Reset device	1 byte for acknowledgment, value hex 1D	
1E	30	Factory-reset device	1 byte for acknowledgment, value hex 1E	

14.6. Error table for BR devices

Depending on the device type, not all error messages are required or supported.

Error number	Error designation	Cause/remedy
0x01+A4:E25	Internal error	All errors that prevent normal operation and over which the customer has no control. - Error in the program files - Error in the light barrier - Safe control of guard locking no longer possible
0x06	Internal error	Fault on the internal switching element. Guard locking can no longer be controlled safely.
0x1F	Actuator not detected often enough during teach-in operation/actuator removed.	See error designation
0x20	DIP switch configuration does not correspond to the software configuration.	DIP switch configuration is not identical to the configuration saved in the memory. The user must check the DIP switch setting.
0x21	DIP switch configuration between the channels not plausible.	DIP switch configuration for the two channels is not plausible or does not match. The user must check the DIP switch setting.
0x25	Invalid actuator detected during teach-in operation.	Actuator detected is not a valid actuator or actuator is faulty.
0x2E	Different states of F11A and F11B	Different signal states at the two safety inputs.
0x2F	Communication error BR (master)	Diagnostics communication between master and slave not possible/communication disrupted
0x31	Test pulse on F11A not detected.	Missing test pulse Examples: short circuits, F11A and F11B swapped.
0x32	Test pulse on F11B not detected.	Missing test pulse Examples: short circuits, F11A and F11B swapped.
0x36	Test pulse on F11A not detected on PowerUp.	Missing test pulse
0x37	Test pulse on F11B not detected on PowerUp.	Missing test pulse
0x43	Disabled actuator detected during teach-in operation.	Already taught in but disabled actuator has been detected. The user must present the taught-in actuator or teach in another actuator.
0x44	Invalid actuator detected	
0x4C	HIGH level on output F01A even though LOW level is expected.	A HIGH level has been detected on safety output F01A during PowerUp.
0x4D	HIGH level on output F01B even though LOW level is expected.	A HIGH level has been detected on safety output F01B during PowerUp.
0x4E	LOW level on output F01A even though HIGH level is expected.	Although safety output F01A has switched off, a HIGH level has been read back.
0x4F	LOW level on output F01B even though HIGH level is expected.	Although safety output F01B has switched off, a HIGH level has been read back.
0x50	Discrepancy time between F01A and F01B too long.	Switch-on/switch-off time between F01A and F01B too long.
0x51	Error on reading back the test pulse on F01A.	Missing test pulse
0x52	Error on reading back the test pulse on F01B.	Missing test pulse
0x54	General output error	
0x60	Supply voltage too high.	Overvoltage
0x61	Supply voltage too low.	Low voltage
0x62	Temperature too high.	Temperature in housing too high.
0x63	Temperature too low.	Temperature in housing too low.
0x64	Guard locking supply voltage too high.	Overvoltage
0x65	Guard locking supply voltage too low.	Low voltage
0x67	Advance warning supply voltage too low 5%.	Low voltage
0x88	Plausibility error: bolt fracture	Transponder for the bolt has been detected without the door closed.
0x8A	Plausibility fault, signal sequence	Transponder has been detected without movement of the locking arm (latch).
0x8B	Escape release	Escape release has been actuated (only if parametrized).

15. Technical data



NOTICE

If a data sheet is included with the product, the information on the data sheet applies.

15.1. Safety relay ESM-CB

- › Diagnostic data via IO-Link in combination with BR safety switches
- › Short circuit detection
- › Plug-in spring terminals
- › 17.5 mm housing width

Approvals



Dimension drawing

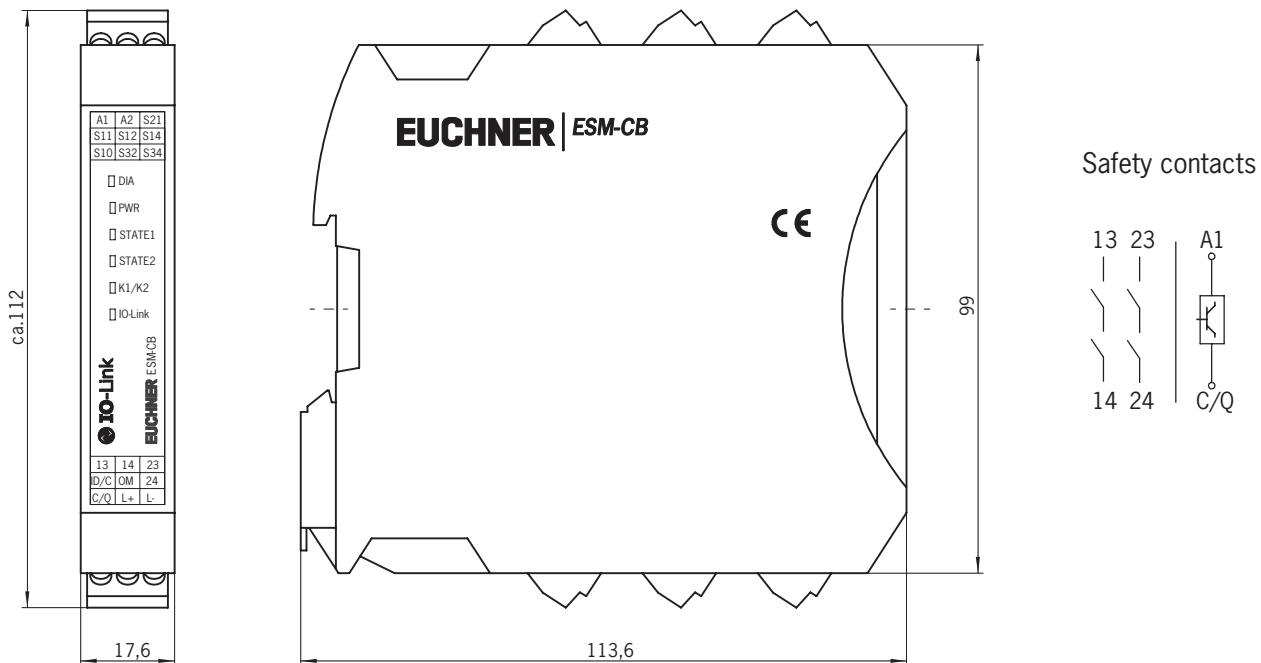

Possible signaling devices

- › Emergency stop pushbuttons
- › Safety door interlocks
- › Light grids

Contact type

- › Two sensor circuits
- › Two non-time-delayed safety contacts
- › One digital monitoring output
- › IO-Link interface
- › The safety contacts drop out without delay in accordance with stop category 0 according to EN 60204-1.

Control

- › Single channel or dual channel
- › Automatic or manual, monitored start

Achievable safety integrity

- › Suitable up to category 4, PL e (EN ISO 13849-1), SIL-CL 3 (EN 62061)

Technical data for ESM-CB

Hardware/firmware version	
HW/FW	≥ 00/100
The technical data and the safety characteristics are valid from the specified HW/FW version.	
Supply	
Name	A1/A2
Operating voltage U_S	24 V DC -20 % / +25 % (fuse externally)
Rated control supply current I_S	Typ. 60 mA
Power consumption at U_S	Typ. 1.44 W
Switch-on current	Typ. 2.5 A ($\Delta t = 500 \mu s$ at U_S)
Filter time	1 ms (at A1 in case of voltage dips at U_S)
Suppressor circuit	Serial reverse polarity protection
IO-Link ports: class A	
Number of ports	1
Connection	Spring terminals
Connection technology	3-conductor
Specification	Version 1.1
Transmission rate	230 kbit/s (COM3)
Cycle time	5 ms
Process-data update	5 ms
Number of process-data items	Max. 31 bytes (input data) Max. 16 bytes (output data)
IO-Link port supply: L+/L-	
Rated periphery supply voltage	24 V DC -20% / +25% (provided via the IO-Link interface of the IO-Link master)
Current consumption	Typ. 16 mA
Suppressor circuit	Serial reverse polarity protection
IO-Link switching and communication line: C/Q	
Number of inputs	1
Digital inputs: sensor circuit S0	
Number of inputs	2 (safety-related sensor inputs: S12, S22)
Description of the input	NPN (S12), NPN/PNP (S22)
Input voltage range of "0" signal	0 V DC ... 5 V DC (S12) For S22, see note in chapter 8.2. <i>Signaling device connection variants.</i>
Input current range of "0" signal	0 mA ... 2 mA (S12, S22)
Input voltage range of "1" signal	11 V DC ... 30 V DC
Switch-on current	< 5 mA (typ. with U_S at S12, $\Delta t = 150$ ms) < 5 mA (typ. with U_S at S22/24 V, $\Delta t = 500 \mu s$) > -5 mA (typ. with U_S at S22/0 V, $\Delta t = 500 \mu s$)
Current consumption	< 5 mA (typ. with U_S at S12) < 5 mA (typ. with U_S at S22/24 V) > -5 mA (typ. with U_S at S22/0 V)
Filter time	1.5 ms (test pulse width for LOW test pulses) Test pulse rate = 5 x test pulse width Deactivate switch-on pulses/light tests on safety applications.
Max. permissible total cable resistance	150 Ω
Input 1/2 simultaneity	∞

Digital inputs: sensor circuit S1	
Number of inputs	2 (safety-related sensor inputs: S32, S34)
Description of the input	NPN
Input voltage range of "0" signal	0 V DC ... 5 V DC
Input current range of "0" signal	0 mA ... 2 mA
Input voltage range of "1" signal	11 V DC ... 30 V DC
Switch-on current	< 20 mA (typ. at U_S)
Current consumption	< 5 mA (typ. at U_S)
Filter time	Max. 1.5 ms (test pulse width for LOW test pulses) Test pulse rate = 5 x test pulse width Deactivate switch-on pulses/light tests on safety applications.
Max. permissible total cable resistance	150 Ω
Input 1/2 simultaneity	∞

Digital inputs: diagnostic input	
Number of inputs	1 (non-safety-relevant diagnostic input: ID/C)
Current consumption	Typ. 30 mA

Digital inputs: start circuit	
Number of inputs	1 (start input: S21)
Description of the input	NPN (manual start), PNP (automatic start)
Input voltage range of "1" signal	19.2 V DC ... 30 V DC (manual start, automatic start: 0 V)
Switch-on current	< 10 mA (typ. for US, $\Delta t = 100$ ms)
Current consumption	< 5 mA (typ. for US at S21/24 V) > -5 mA (typ. for US at S21/0 V)
Max. permissible total cable resistance	150 Ω

Safety contacts	
Number of outputs	2 (safety-related normally open contacts: 13/14, 23/24)
Description of the output	Respectively 2 NO in series, non-time-delayed, floating
Contact material	AgSnO ₂
Switching voltage	Min. 12 V AC/DC Max. 250 V AC/DC (observe load curve)
Limiting continuous current	6 A
Switch-on current	Min. 3 mA Max. 6 A
Square total current $I_{TH2} = I_{12} + I_{22} + \dots + I_{N2}$	72 A ² (observe derating)
Breaking capacity	Min. 60 mW
Switching frequency	0.5 Hz
Mechanical life	10x 10 ⁶ operating cycles
Switching capacity acc. to IEC 60947-5-1	4 A (24 V (DC13)) 5 A (250 V (AC15))
Output fuse	6 A gL/gG 4 A gL/gG (for low-demand applications)

Monitoring outputs	
Name	OM
Number of outputs	1 (not safety relevant)
Description of the output	PNP
Voltage	Approx. 22 V DC ($U_S - 2$ V)
Current	Max. 100 mA
Max. switch-on current	500 mA ($\Delta t = 1$ ms with U_S)

General data	
Relay type	Electromechanical relay with positively driven contacts according to IEC/EN 61810-3 (EN 50205)
Nominal operating mode	100% duty cycle
Degree of protection	IP20
Minimum degree of protection of installation location	IP54
Mounting method	Rail mounting
Installation orientation	Vertical or horizontal
Mounting instructions	See derating curve
Housing version	PBT gray
Operating voltage indication	1 x LED green, yellow, red
State indication	5x LEDs, green
Air clearances and creepage distances between the circuits	According to DIN EN 60947-1
Rated insulation voltage	320 V
Rated insulation voltage/insulation See chapter "Insulation coordination"	Basic insulation 4 kV between all current paths and housing Safe isolation, reinforced insulation 4 kV between input circuit and safety contact (13/14) and safety contact (23/24)
Degree of contamination	2
Overvoltage category	II
Max. power dissipation at rated condition	6.45 W (US = 30 V, UL = 30 V, I ² = 72 A ²)
Note about power dissipation	See chapter "Calculating the power dissipation"
Dimensions	
W x H x D	Housing 17.5 x 116.6 x 114.5 mm
Connection data	
Conductor cross-section, rigid	Spring terminals 0.2 mm ² ... 1.5 mm ²
Conductor cross-section, flexible	0.2 mm ² ... 1.5 mm ²
Conductor cross-section, AWG/kcmil	24 ... 16
Stripping length	8 mm
Ambient conditions	
Ambient temperature (operation)	-25 °C ... 60 °C (observe derating)
Ambient temperature (storage/transport)	-40 °C ... 85 °C
Max. perm. atmospheric humidity (operation)	75% (on average, 85% occasionally, no dew formation)
Max. perm. atmospheric humidity (storage/transport)	75% (on average, 85% occasionally, no dew formation)
Shock	15 g
Vibration (operation)	10 Hz ... 150 Hz, 2 g
Safety engineering data	
Stop category according to IEC 60204	0
Safety engineering characteristics for IEC 61508 – high demand	
Device type	Type A
HFT	1
SIL	3
PFFH _D	1.00 x 10 ⁹ (4 A DC13; 5 A AC15; 8,760 operating cycles/year)
Demand rate	< 12 months
Proof-test interval	240 months
Mission time	240 months

Safety engineering characteristics for IEC 61508 – low demand

Device type	Type A
HFT	1
SIL	3
PF _{Davg}	3.76 x 10 ⁻⁵
Proof-test interval	36 months
Mission time	240 months

Safety engineering characteristics according to EN ISO 13849 depending on the switching current

at 24 V DC	≤ 0.1 A	≤ 1 A	≤ 4 A
Category		4	
PL		e	
PFH _D		1 x 10 ⁹	
Mission time		20 years	
Switching cycles/year	500,000	50,000	15,000

Safety engineering characteristics for EN 62061

SILCL	3
-------	---

A demand rate of the safety function of once per month is required for applications in SILCL 3.

15.2. Function and time diagrams

15.2.1. Time diagram for automatic start

Continuous auto start

► Permanently High signal at S21

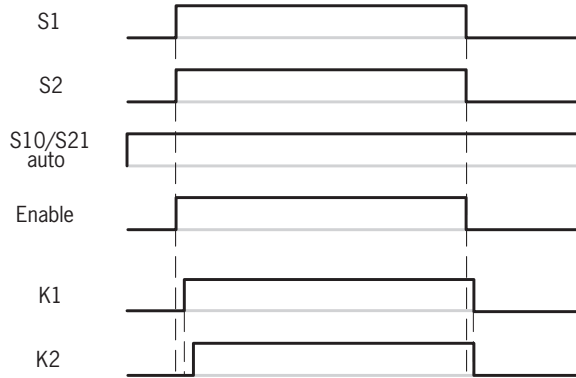

Figure 9: Time diagram for automatic start

15.2.2. Time diagram for manual, monitored start

► Start on falling edge at S21

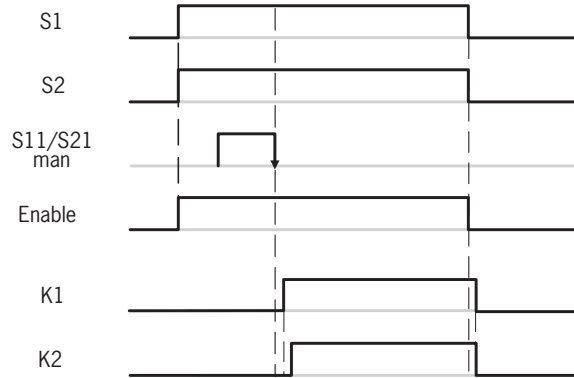

Figure 10: Time diagram for manual, monitored start

Autostart pulse

► Start on rising edge at S21

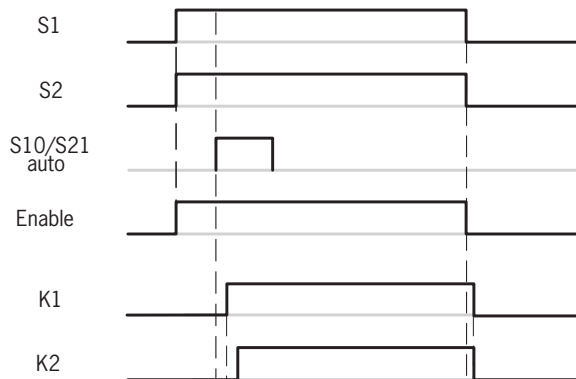

Figure 11: Time diagram for automatic start

Time diagram for enable principle

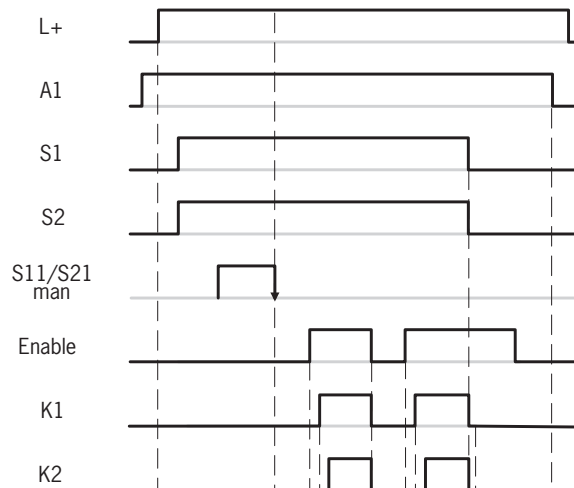

Figure 12: Time diagram for enable principle

Key:

S1/S2	Sensor circuits
S10/S21 auto	Start circuit for automatic start
S11/S21 man	Start circuit for manual, monitored start
K1/K2	Output circuits
L+	IO-Link supply
A1	Power supply
Enable	Enable signal via IO-Link

15.3. Derating

15.3.1. Vertical or horizontal installation orientation

The derating curve is applicable under the following conditions:

- Mounting on vertical or horizontal mounting rail
- Devices mounted without intervening distance
- At U_S up to max. 30 V DC

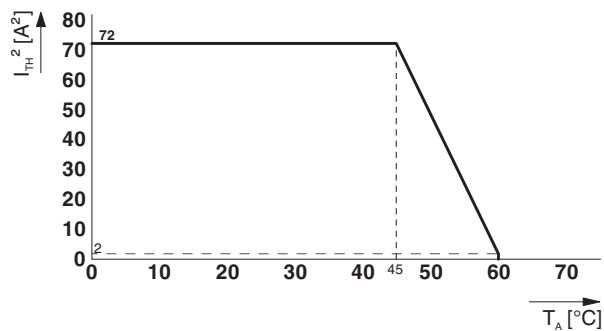

Figure 13: Derating curve

15.4. Load curve

15.4.1. Resistive and inductive loads

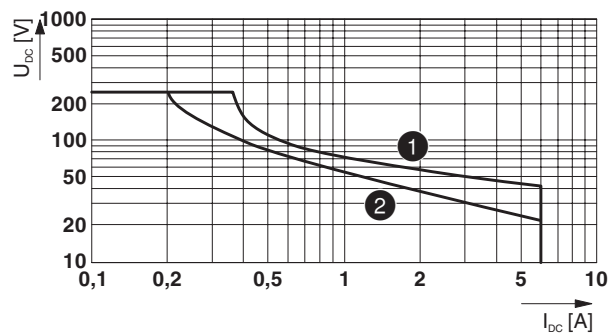

Figure 14: Relay load curve – resistive and inductive loads

Key:

- ① Resistive load $L/R = 0$ ms
- ② Inductive load $L/R = 40$ ms

16. Ordering information and accessories

**Tip!**

Suitable accessories, e.g. cables or assembly material, can be found at www.euchner.com. To order, enter the order number of your item in the search box and open the item view. Accessories that can be combined with the item are listed in "Accessories."

17. Inspection and service

**WARNING**

Loss of the safety function because of damage to the device.

- › In case of damage, the entire device must be replaced.
- › Only accessories or spare parts that can be ordered from EUCHNER may be replaced.

Regular inspection of the following is necessary to ensure trouble-free long-term operation:

- › Check the function (see chapter 12. *Function test*)
- › Check the secure mounting of the devices and the connections
- › Check for soiling

No servicing is required. Repairs to the device are only allowed to be made by the manufacturer.

**NOTICE**

The year of manufacture can be seen on the rating plate below the CE marking. The current version number in the format HW/FW: xx/xxx can also be found on the device.

18. Service

If service support is required, please contact:

EUCHNER GmbH + Co. KG
Kohlhammerstraße 16
70771 Leinfelden-Echterdingen

Service telephone:

+49 711 7597-500

E-mail:

support@euchner.de

Internet:

www.euchner.com

19. Declaration of conformity



EUCHNER

More than safety.

EU-Konformitätserklärung
EU declaration of conformity
Déclaration UE de conformité
Dichiarazione di conformità UE
Declaración UE de conformidad

Original DE
Translation EN
Traduction FR
Traduzione IT
Traducción ES

2522665-01-03/19

Die nachfolgend aufgeführten Produkte sind konform mit den Anforderungen der folgenden Richtlinien (falls zutreffend):
The beneath listed products are in conformity with the requirements of the following directives (if applicable):
Les produits mentionnés ci-dessous sont conformes aux exigences imposées par les directives suivantes (si valable)
I prodotti sotto elencati sono conformi alle direttive sotto riportate (dove applicabili):
Los productos listados a continuación son conforme a los requisitos de las siguientes directivas (si fueran aplicables):

I:	Maschinenrichtlinie Machinery directive Directive Machines Direttiva Macchine Directiva de máquinas	2006/42/EG 2006/42/EC 2006/42/CE 2006/42/CE 2006/42/CE
II:	EMV Richtlinie EMC Directive Directive de CEM Direttiva EMV Directiva CEM	2014/30/EU 2014/30/EU 2014/30/UE 2014/30/UE 2014/30/UE
III:	RoHS Richtlinie RoHS directive Directive de RoHS Direttiva RoHS Directiva RoHS	2011/65/EU 2011/65/EU 2011/65/UE 2011/65/UE 2011/65/UE

Folgende Normen sind angewandt:
Following standards are used:
Les normes suivantes sont appliquées:
Vengono applicate le seguenti norme:
Se utilizan los siguientes estándares:

a: EN ISO 13849-1:2015
b: EN 62061:2005+AC:2010+A1:2013+A2:2015
c: EN 61000-6-4:2007 + A1:2011
d: EN 61326-1:2013
e: EN 50581:2012 (RoHS)

Bezeichnung der Bauteile Description of components Description des composants Descrizione dei componenti Descripción de componentes	Type Type Type Tipo Tipo	Richtlinie Directives Directive Direttiva Directivas	Normen Standards Normes Norme Estándares	Zertifikats-Nr. No. of certificate Número du certificat Numero del certificato Número del certificado
Sicherheitsrelais Safety Relay Relais de sécurité Relais di sicurezza Relé de seguridad	ESM-CB...	I, II, III	a, b, c, d, e	01/205/5698.00/19

Benannte Stelle
Notified Body
Organisme notifié
Sede indicata
Entidad citada

NB 0035
TÜV Rheinland Industrie Service GmbH
Alboinstraße 56
12103 Berlin
Germany

Die alleinige Verantwortung für die Ausstellung dieser Konformitätserklärung trägt der Hersteller:
This declaration of conformity is issued under the sole responsibility of the manufacturer:
La présente déclaration de conformité est établie sous la seule responsabilité du fabricant:
La presente dichiarazione di conformità è rilasciata sotto la responsabilità esclusiva del fabbricante:
La presente declaración de conformidad se expide bajo la exclusiva responsabilidad del fabricante:

EUCHNER GmbH + Co. KG
Kohlhammerstraße 16
70771 Leinfelden-Echterdingen
Germany

Leinfelden, März 2019

EUCHNER GmbH + Co. KG
Kohlhammerstraße 16
70771 Leinfelden-Echterdingen
Germany

i.A. Dipl.-Ing. Richard Holz
Leiter Elektronik-Entwicklung
Manager Electronic Development
Responsable Développement Electronique
Direttore Sviluppo Elettronica
Director de desarrollo electrónico

i.A. Dipl.-Ing. (FH) Duc Binh Nguyen
Dokumentationsbevollmächtigter
Documentation manager
Responsable documentation
Responsabilità della documentazione
Agente documenta

Euchner GmbH + Co. KG
Kohlhammerstraße 16
70771 Leinfelden-Echterdingen
info@euchner.de
www.euchner.com

Edition:
2522722-01-05/19
Title:
Operating Instructions Safety Relay with IO-Link ESM-CB
(Translation of the original operating instructions)
Copyright:
© EUCHNER GmbH + Co. KG, 05/2019

Subject to technical modifications; no responsibility is accepted for the accuracy of this information.